



Omnilight II

RM 1100

Portable Data Acquisition System

Powerful and Dependable

RM1100 Excels in both Lab and Field

The Compact RM1100 Portable Data Recorder provides reliable data collection in challenging environments. A large 7-inch wide TFT LCD color touch screen display and refined GUI are ideal for quick Setup, Data Capture and Playback. Coupled with "Real Time", "Memory" and SD Card recording modes plus up to 1 μ sec sampling rate, the RM1100 handles the most demanding high speed applications. Recording to SD Card or PC via Ethernet ensures long time continuous recording. Waveform printing is available with optional thermal printer. This AC or battery-operated recorder with rugged casing satisfies your different requirements for Predictive Maintenance, Quality Control, R&D, Automobile Driving Test and remote-controlled data acquisition.



Signal Input up to 8 Channels

4 or 8 channels of both Voltage/Temperature and Logic inputs

Outstanding Usability

Dynamic waveform display on 7" wide & large LCD
Touch-screen with GUI offers easy operation

Built Tough

Shock and drop resistance withstanding continuous vibration environments such as on-board vehicle tests (MIL-STD-810G 514.5C-1)

Wide operating temperatures:-20°C to +60°C (-4°F to +140°F)
Compact & rugged case endures dusty and humid environments

Excellent Portability

Long term continuous operation with rechargeable batteries. Can also be powered with 8.5 ~ 24V DC (vehicle) as well as AC Lightweight (approx. 1.5kg/ 3.3lbs) with full feature measurement capability

Measurement Capability

Three measuring modes: "Real-Time" (Paper), "Memory" (Snap-Shot) and "Filing" (SD card storage)
High speed recording up to 1 μ s (1MS/s) to Memory or SD card
Long term recording to SD Card, PC or optional thermal printer

NIPPON AVIONICS CO., LTD.

An NEC Group Company

■ Robustly Designed, Sturdy Construction



■ Shock Resistant Rugged Casing

Small, lightweight instruments can be prone to be slipped off from workbench or dropped during field test and transportation. RM1100 is good built-quality withstands harsh drop test (IEC60068-2-32 equivalent: 1 meter drop onto flat aluminum plate with the unit not being operated).*

■ Endurance in Dusty and Humid Conditions

The product design was tested to comply with IEC60529 standard with optional splash-resistant cover (RM11-402) installed for input terminals, power supply and connecting cables. When adequately installed, RM1100 can be used in tough environments with dust or mist in the air. 180° Flip Display mode allows RM1100 installed and used upside down with cables hooked up to the bottom.

180° Display Flip feature allows RM1100 use with connectors projecting from top or bottom of unit.



■ Vibration Resistance Ensuring Stable Measurement for Automotive Testing etc.

RM1100 conforms to U.S. standard MIL-STD810G 514.5C-1 that is often required or desired for vehicle tests and other applications.

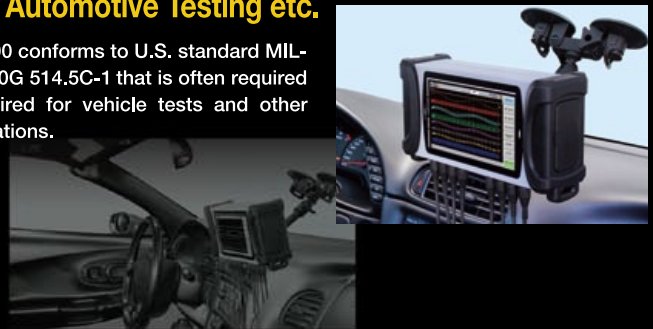

■ Wider Operating Temperatures: -20°C to +60°C (-4°F to +140°F)

The extended operating temperature range lets you take RM1100 to perform testing in hot or cold environments, such as in thermostatic chambers, a certain proximity to furnace or other heat generating machineries, warehouses and automobiles in summer and winter. When used in-vehicle, for instance, RM1100 can be booted up to start recording right away. (Test confirms continuous and normal operation at -20°C and +60°C and RM1100 kept at -20°C for 60 min with no power supplied can be turned on and be operated properly.)



*The above specifications and tests don't guarantee failure-free or breakage-free performance.

Versatile Measuring Capability

Multiple Measuring Modes

Select from 3 measuring modes— ‘Memory Mode’ for saving fast events, ‘Filing Mode’ for saving data for long periods of time on an SD card, and ‘Real-time Mode’ for printing out waveforms using an external printer.

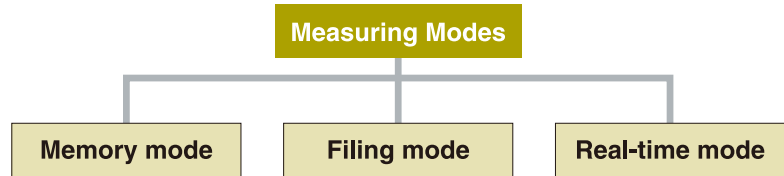

Memory mode

Data is saved to built-in memory (2M data/channel) at a maximum speed of $1\ \mu\text{s}$ (1M samples/second). Measured data is displayed, printed with an external printer, or saved on a SD card.

Sampling speed: $1\ \mu\text{s}$ to 1sec



Printer

SD Card

Sampling speed	$1\ \mu\text{s}$ to 1s
Memory size	2M data/channel
Data length	1000 to 2M data (10 to 20,000 divisions)
Memory divisions	1, 2, 5, 10, 20, 50, 100
Pre-trigger mode	

Memory Recording Time

Sampling speed	Memory (2M samples)
1_s	2 sec
2_μs	4 sec
5_μs	10 sec
10_μs	20 sec
20_μs	40 sec
50_μs	100 sec
100_μs	200 sec
200_μs	400 sec
500_μs	1000 sec
1ms	33 min 18 sec
2ms	1 hr 6 min 40 sec
5ms	2 hr 46 min 40 sec
10ms	5 hr 33 min 20 sec

SD card slot



Supports optional SD card

Real-time mode

Real-time recording mode allows acquired data to be sent directly to an external printer. Waveforms are shown on the color display screen using graphical pen tips. The chart paper speed may actively be changed during recording using the touch screen.



Specifications

Chart speed	10mm/sec to 1mm/min
Recording Division	1, 2, 4, 8 divisions
Printing Density	8dots/mm (time axis: horizontal) 8dots/mm (waveform axis: vertical)
Paper Width	112mm

Filing mode

Filing mode provides long-time data saving to an SD card. Record data at fast sampling rates up to $1\ \mu\text{s}$ (1M samples/sec) with 1 channel or $10\ \mu\text{s}$ (100K samples/sec) simultaneously with eight (8) activated channels. This feature is excellent for high speed and long term continuous recording as well as post-measurement analysis.

Sampling speed: $1\ \mu\text{s}$ to 1sec



Sampling speed	1MS/s ($1\ \mu\text{s}$) to 1S/s
	**Varies by number of activated channels or data type
Filing Format	Linear / Loop

Maximum Recording time to SD card

Sampling speed	8GB capacity	
	With 1 channel	With 8 channels
1_μs	1hr 11min	—
2_μs	2hr 23min	—
5_μs	5hr 57min	44min 44sec
10_μs	11hr 55min	1hr 29min
20_μs	23hr 51min	2hr 58min
50_μs	2d 11hr 39min	7hr 27min
100_μs	4d 23hr 18min	14hr 54min
200_μs	9d 22hr 36min	1d 05hr 49min
500_μs	24d 20hr 31min	3d 02hr 34min
1ms	49d 17hr 02min	6d 05hr 07min
2ms	99d 10hr 05min	12d 10hr 15min
5ms	248d 13hr 13min	31d 01hr 39min
10ms	497d 02hr 27min	62d 03hr 18min

**Above Recording times are for Sampled data.
Recording times are doubled for Peak data sampling.

What is Sample data or Peak data?

Both Sample and Peak data may be recorded on the RM1100. Sample-data recording, a method used in most data acquisition systems, records data at preset time intervals. Peak-data recording scans measured data at a very fast speed and records projecting (Peak) data. This method records high-frequency noise regardless of printer paper feed speed. Figures on the right show examples of both Sample and Peak data recorded at a sampling rate of 10ms.

Sample data

Measured data is recorded at preset time intervals only. Any event occurring between the set interval is not recorded.

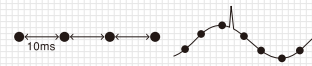

Peak data

Measured data is scanned at the fastest sampling speed, between a preset time interval. The highest and lowest values are recorded. This allows recording any fast projecting (Peak) data while minimizing the amount of data stored. Approx. twice as much data is stored with the Peak data mode compared to the Sample data mode.

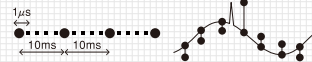

X-Y Display

An XY graph can be displayed in Memory mode and Filing mode. With this graph, correlation between X and Y axis is easily viewed. Up to three (3) channels may be selected for each axis and a graph (800 x 800 dots) viewed or printed.

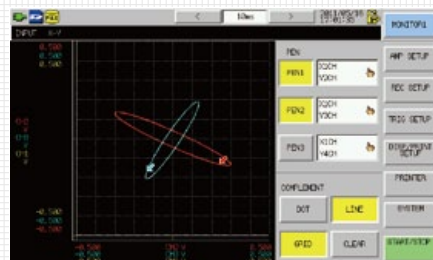

Functions to Support Measurement on Site

Dynamic Waveform Display

The wide 7" LCD allows dynamic waveform display of up to 8 channels. Users can also set numeric value and waveform screen division for various purposes.

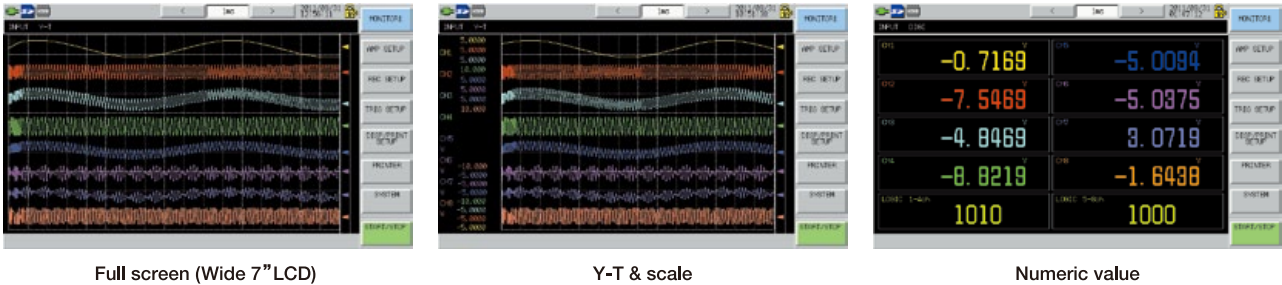

Intuitive Operability

RM1100's large touch screen panel enables users to operate it intuitively. Touching button or cursor on screen makes it simple and easy to perform various setting, scrolling and moving cursors.

Simple setting of sampling & paper feed speeds

RM1100's large touch screen panel enables users to operate it intuitively. Touching button or cursor on screen makes it simple and easy to perform various setting, scrolling and moving cursors.

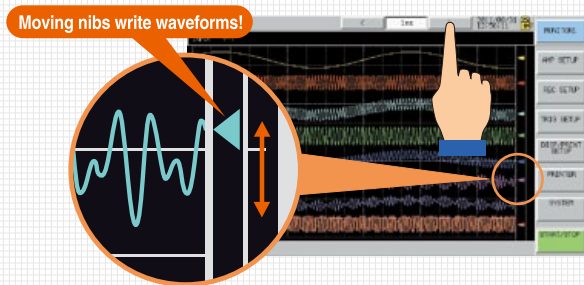

Thumbnail bar

An entire waveform of acquired data (selected 1 channel) can be displayed on a thumbnail bar. By touching a point of interest on the bar, users can see enlarged waveform on the main playback screen.

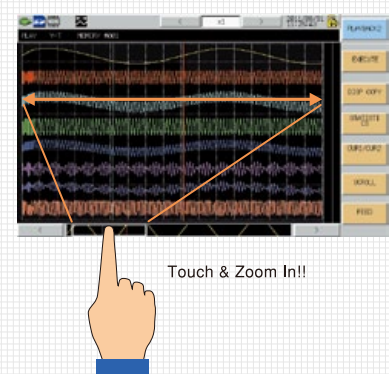

Function menu

Touching menu button on the top right extends function menu for data input or playback.

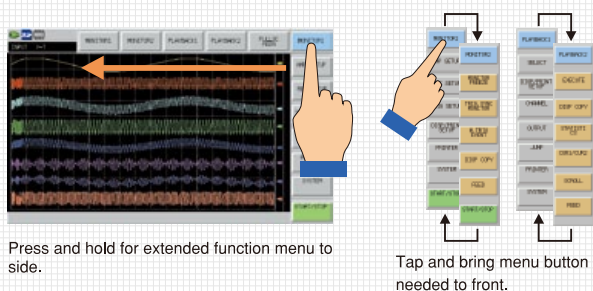

Cursor data readout

Displays max, min, average and peak value in-between 2 cursors (time axis) given on playback screen.



Changing signal position & waveform width

Touching near input signals pops up a dialog box for changing signal position & waveform width, and allows to select channel, position UP/DOWN or expand/shrink width of waveform.

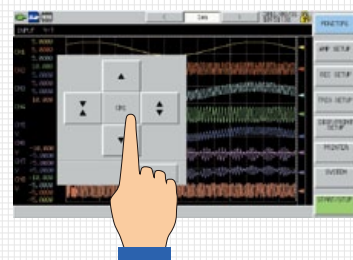

Trigger-level setting

When setting a trigger level, users can just touch and move cursor (threshold) over waveform on screen to change setting.

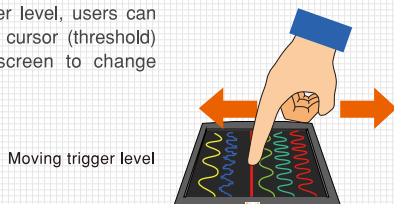

Convenient Features and More

Useful Functions

Timer-control Function

Automatic measurement with preset time and interval.

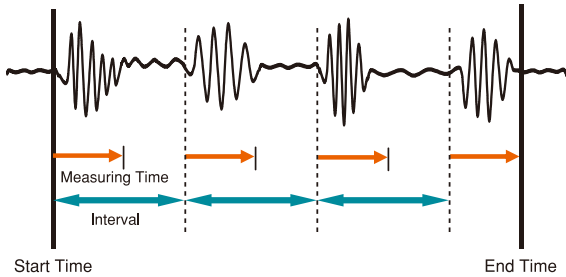

Flipped monitor display

RM1100 can be positioned upside-down and still display data correctly. A flipped screen secures flexibility in connecting cables to suit the location where the product is installed. With optional mount (RM11-405), VESA standard display monitor arms, stands and brackets can be chosen for your installation.



Unifizer LE for DAQ (PC software)

The software as a standard accessory enables remote controlled operation via Ethernet: setting, recording (to PC), playback and post-analysis.

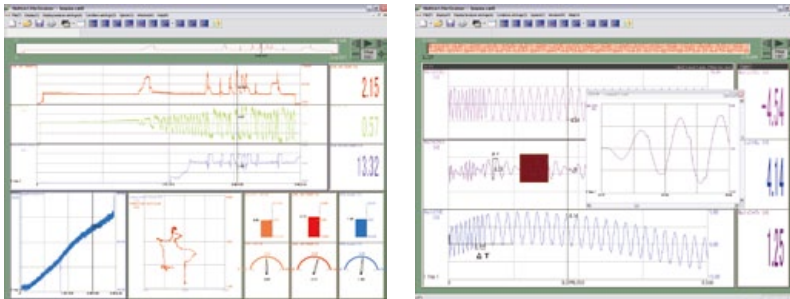

Connection with RM1100

Control RM1100 via Ethernet and also read data saved on a SD card.

User-customized Screen Displays

- 1) **Parallel display of Record & Play screens:**
Display Digital Data, Y-T graphs, X-Y graphs, and Bitmap Data on screen with customized layouts.
- 2) **Report function:**
Insert comments or arrows to waveforms on screen and print the images for reporting.

Numerous calculation functions

Arithmetic, Calculus and Trigonometric Functions, FFT, etc. using real-time or post-measurement data.







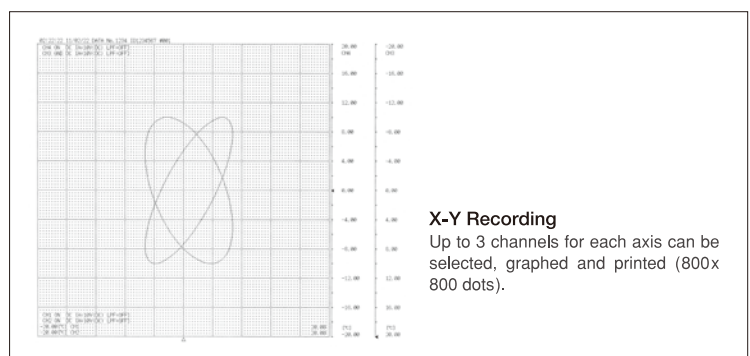
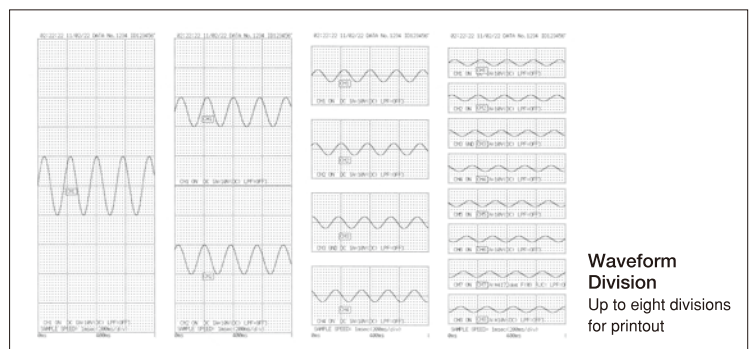
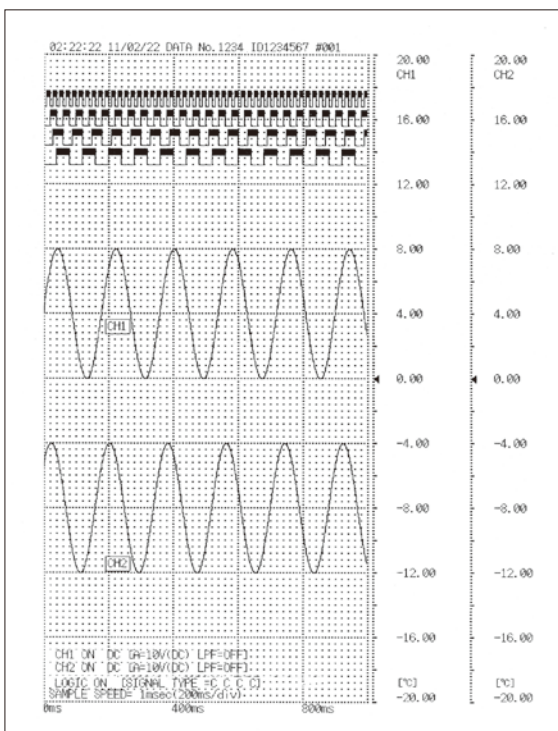





*For Microsoft Windows Vista and 7™. Compatible PC configuration, OS system and associated application software are to be consulted beforehand.

Printing Feature

Data can be printed on a recording chart at a paper speed of 10mm/sec. Recorded waveform data of selected channels can also be printed in different formats; by channel or overlapping etc. Signal position and amplitude can be easily adjusted independently for each channel.

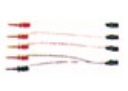

Block Diagram for Selecting Options

Input Signal	Probes and Cables
Voltage ±500V (DC or AC peak)	Isolated BNC cable (0311-5175)  BNC-safety jacks adapter (0243-3021) 
Current High current Medium current Low current	AC/DC Clamp Meter 2009R 2,000A, 400A / DC, 30 to 1kHz DC, 30 to 1kHz φ55  Input cable 0311-5184 required
	Clamp Adaptor 8113 200A, 20A, 2A DC to 1kHz φ19  Clamp Sensor 8115 AC130A, DC180A DC, 40 to 1kHz φ12 
	Clamp Adaptor 8112 20A, 2A, 0.2A 40 to 10kHz φ8  BNC-safety jacks adapter (0243-3021) 
Voltage fluctuation ±10% and ±20% 100V type, 200V type	1540S: 100V type / 1543S: 200V type This unit detects voltage fluctuations of power line. 10% and 20% of 100 VAC or 200 VAC lines can be detected  1540S/1543S
Voltage detection 50-250VAC 20-250VDC	This unit detects AC or DC voltage and outputs as High/Low. It supports 4 channels 50 to 150VAC: Low 100 to 250VAC: High 20 to 150VDC: Low 80 to 250VDC: High  1539S
Temperature Thermocouple R, T, J, K and W	Covered and sheathed thermocouples 
Logic	Alligator clip code (0311-5336)  IC clip code (0311-5337)  Logic IC cable (for 5V input) (0311-5332) 
	Rotational Signal At voltage input 0.3V to 30V p-p 1Hz to 10kHz Rotation pulse

RM1100 Input
Voltage input - ±100mV to ±500V - 1MS/s (1 μs) - A/D: 14bit
Temperature input Thermocouple (R, T, J, K, W) - 1MS/s (1 μs) - A/D: 14bit
Logic input - At voltage input (0 to +5V) or At contact (short or open)



Battery pack
(T2UR18650F-5928)

Battery charger
(NC-LSC05-100V)

Splash-resistant cover
(RM11-402)





Carrying case
(RM11-403)

Thermal printer
(RM11-440)

Display arm mount
(RM11-405)

Recording paper
(YPS118)

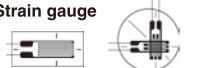
SD memory card
(RM11-452, RM11-453, RM11-454)

Input Signal	Sensor
Vibration (impact acceleration)	Amp-embedded charge accelerometer (SV2000 series) 
	Piezoelectric accelerometer (SV, 9F, 9G series)  Charge converter This unit is necessary when piezoelectric accelerometers are used. AP11-901 AP11-902 AP11-903 
Strain, load, displacement, acceleration and torque	Strain gauge  Bridge box 
	Strain gauge sensors: Load cell, pressure transducer, displacement transducer, torque transducer, slip ring and accelerometer 

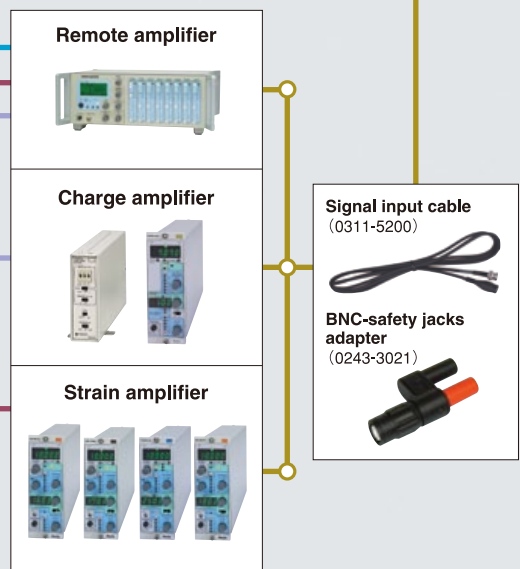

Remote amplifier

Charge amplifier

Strain amplifier

Signal input cable
(0311-5200)

BNC-safety jacks adapter
(0243-3021)

Specifications

■ Omnilight II RM1100 Series

Type	RM1101	RM1102
Display	7 inch TFT LCD display (800 x 480 dots)	
Operation panel	Touch panel	
Input		
Channel	4ch	8ch
Voltage/Temperature Logic	4ch	8ch
Sampling Speed	with 1ch : 1MS/s (1 μ s) to 1S with 2ch : 500K/s (2 μ s) to 1S with 4ch : 200K/s (5 μ s) to 1S	with 1ch : 1MS/s (1 μ s) to 1S with 2ch : 500K/s (2 μ s) to 1S with 4ch : 200K/s (5 μ s) to 1S with 8ch : 100K/s (10 μ s) to 1S
Trigger		
Source Ch	4ch + Logic 4ch	8ch + Logic 8ch
Detecting Mode	OR, AND, OFF, TIMER	
Kind of Trigger (Analog)	Level Trigger, Window	
Storage Media	Internal Memory 2,000,000 data/ch External Media SD Card, corresponding to SDHC	
Communication		
Interface	-LAN (10/100BASE-T) -RS-232C (for Thermal printer)	
External Control Terminals	REC ON/OFF, TRIGGER-IN, TRIGGER-OUT, MARK-IN	
Operating Environment		
Temperature/Humidity	Temperature: -20 to 60°C, Humidity: 35 to 80%RH	
Vibration Resistance	-compatible with MIL-STD-810G 514.5C-1 10Hz to 500Hz, Random wave 1hour each to X, Y, Z directions.	
Dust-proof / Splash-proof Construction	IP41 (IEC60529) when optional RM11-402 Splash-resistant cover is used	
Power Supply	-AC adaptor: IN 100 to 240V AC (50/60Hz)/OUT 12V DC -DC power: 12VDC(with power cable: 8.5 to 24V DC) -Battery: AC adaptor is prior to battery operation	
Battery Type/Operation Time	Li-Ion rechargeable batteries (4 hours in continuous use)	Li-Ion rechargeable batteries (3 hours in continuous use)
Power Consumption	approx. 9W	approx. 11W
Dimensions	267(W) X 152(H) X 84(D)mm (excluding projection)	
Weight	Approx.1.5kg (not include AC adapter and battery weight)	
Measurement Modes	Memory Mode (For saving on Memory) Filing Mode (For long-time saving on a SD card) Real-time Mode (For printing out to an external printer)	
Memory Mode		
Memory Recording	Memory Capacity 2,000,000 data/ch Memory Division Division: 1 to 100 div Number of data: 1000 to 20,000; 1,000 to 2,000,000 data	
Memory Filing	Storage Device SD card Data Form Data is saved on SD card in binary format every time when it is stored in memories.	
Waveform Printing	Printing Density Voltage axis: 8 dots/mm, Time axis: 8 dots/mm Copy Magnification x100, x50, x20, x10, x5 to x1/10,000	
Real-time Mode		
Printer	Print out to an optional thermal printer via a single purpose cable	
Recording Speed	Max. 10mm/sec	
Recording Division	1, 2, 4 divisions	1, 2, 4, 8 divisions
Time axis	Numeric value (Number of divisions), Time (from start recording) and Clock are printed.	
Recording Resolution	Time axis: Max. 8 dots/mm, Voltage axis: 8 dots/mm	
Filing Mode		
Memory Media	SD card	
Data format	Sampling data, Peak data	
Recording Method	Normal or Ring recording (repeated recording during preset time) selectable.	
X-Y Recording		
Drawing Speed	100ms to 1s	
Number of X-Y Display	Max. 3 X-Y displays (Specify optional 3ch for X and Y axes)	
Recording size	100 X 100mm	
Recording Resolution	800 X 800 dots (80 dots/DIV)	
Measured Data Display (Replay Monitor)		
Waveform Division	1 to 4 divisions	1 to 8 divisions
Display Magnification	x 100 to x 1/10,000 (** Peak style is not enlarged)	
Thumbnail Function	Display whole data of selected one channel on a thumbnail bar	
Numeric Display	4ch + Logic 4ch	8ch + Logic 8ch
Search Function	Search by cursor, time, address and event	
X-Y Display channel number	Printout displayed waveforms (X-axis: 3ch, Y-axis: 3ch)	
Printout Function		
Data Information	Measuring mode, year/month/day, measurement start time, data number, triggerconditions (trigger point, trigger date, trigger time), sampling speed, paper speed, time axis can be printed with waveforms, ON/OFF selectable.	
Channel Information	Print input unit settings when saved, ON/OFF selectable.	
Mark Print	Filing mode, Real-time mode, mark (date/time) print	
Line Width for Printing	Select base line boldness for each channel (1, 2, 3, or 4 dots)	
Screen Copy	Print screen image on recording paper	
Other Specifications		
Multiple Language menu	10 Languages (English, French, German, Italian, Japanese, Korean, Portuguese, Spanish, Simplified Chinese and Traditional Chinese)	
Timer Function	Start time, end time and interval can be set.	
Reverse Display	Provided	
Save/Readout of Settings	Measuring conditions can be saved-Internal memory: up to 4 conditions, SD card: up to available storage space.	
Screen Image Saving	Save screen image on SD card at BMP format (colored)	
Brightness control & Auto Off	Provided	
Reading values between cursors	Max, min, average, p-p, RMS	
Key Lock	Provided	
Voltage Input		
Input channel	4ch	8ch
Input Terminal	Isolated BNC connector	
Input Format	Isolated unbalanced input	
Input Coupling	AC and DC coupling	
Input Impedance	1M Ω or more	
Input Range	\pm 0.1, 0.2, 0.5, 1, 2, 5, 10, 20, 50, 100, 200,500 V \cdot FS	
Accuracy	Range Accuracy within \pm 0.3% FS Linearity within \pm 0.1% FS	
Offset Accuracy	within \pm 0.3% FS	
Max input voltage	\pm 500V(DC or AC peak values)	
Allowable Input Voltage	Range of \pm 5V to 500V: \pm 500V max (DC or AC peak values) Range of \pm 0.1V to 2V: \pm 40V max (DC or AC peak values)	
CMV	42V (DC or AC peak values) When using isolated BNC cable(optional): 300VAC	
Frequency Response (W/B)	DC coupling : DC to 400kHz (+0.5, within -3dB) AC coupling : 1 to 400kHz (+0.5, within -3dB)	
Low Pass Filter	2 pole besseI type, -12dB/oct 5Hz, 50Hz, 500Hz, 50kHz, OFF	
Common Mode Rejection Ratio (CMRR)	80dB or more (at short input, 60Hz)	
Temperature Stability	Zero drift : Within \pm 0.03%/FS \cdot C Sensitivity : Within \pm 0.01%/FS \cdot C at range \pm 100mV \cdot FS	
Withstand Voltage	1.5kV AC(50/60Hz), 1min between input terminal - case or terminals	
A/D Converter	Resolution 14bit,Conversion speed 1 μ s	

Type	RM1101	RM1102
Temperature Input		
Input channel	4ch	8ch
Input Terminal	M3 screw terminal block	
Thermocouple	R, T, J, K, W	
Cold Junction	Internal/external switchable.	
Cold Junction Compensation	within \pm 2°C (within \pm 1°C at stable temperature of 20°C at input terminal)	
Measuring Range	R type thermocouple R1760 (0~1760°C) T type thermocouple T400 (-200~400°C) J type thermocouple J1100 (-200~1100°C) K type thermocouple K500 (-200~500°C) K1370 (-200~1370°C) W type thermocouple W2300 (0~2300°C)	
Range Accuracy	Within \pm 0.5% FS	
Frequency Characteristics	DC to 50kHz (+0.5,within -3dB)	
Low Pass Filter	2 pole besseI type, -12dB/oct 5Hz,50Hz,500Hz,50kHz	
Common Mode Rejection Ratio (CMRR)	80dB or more (at short input, 60Hz)	
Temperature Stability	within \pm 0.04% FS/C: When used as temp amp/gain(R1760, T400, K500 Range)	
Withstand Voltage	1.5kV AC(50/60Hz), 1min between input terminal - case or terminals	
A/D Converter	Resolution 14bit,Conversion speed 1 μ s	
Logic Input		
Number of Channel	4ch	8ch
Input Connector	Circle DIN mini connector 1 pc	Circle DIN mini connector 2 pcs
Input	Logic input (isolated: between ch - case)	
Input Signal	Set up voltage/contact input for each channel	
Voltage Input	Input voltage range : 0 to +5V (with logic cable: Input voltage 0 to 24V) Detecting level: H approx. 2.5V or more, L approx. 0.5V or less Input current: 1 μ A	
Contact Input	-Detection level: Short(H) ... 250Q or less Open(L) ... 2kQ or more -Load current: Max. 2 mA	
Response Time	Within 1 μ s (at input "H", level +5V or higher)	
Data Saving	Record '1' or '0' when logic level is 'H' or 'L' respectively	
Isolated Impedance	Between Input terminal - Ground : 100M Ω or more	
Withstand Voltage	Between input terminal - Ground : 500V AC for 1 min.	

Thermal Printer RM-440 Specifications

Print	
Type	Thermal line dot
Dot/line	832 dots/line
Resolution	8 dots/mm
Paper width	112mm
Print width	104mm
Paper type	Rolled paper
Power source	AC adapter(exclusive), Optional Li-ion battery
Communication type	Serial
Operation temperature	At discharge: 0 to 50 °C At charge: 0 to 35 °C
Humidity	30 to 80%RH (No condensation)
Printer lifetime	50km
Dimension	W145 X D135 X H58 mm
Weight	Approx. 400g (not include AC adapter and battery weight)
Standard accessories	AC Adaptor, Operation Manual, Recording paper, Printer cable (For an optional thermal printer via a single-purpose cable)

■ Dimensions



The product specifications and design are subject to change without notice.

Main Unit & Accessories

Omnilight II RM1100 Series Main Unit

Item	Model	Option Code		Description and Remarks
Omnilight II	RM1101	—	<input type="checkbox"/>	4ch type
	RM1102	—	<input type="checkbox"/>	8ch type
Standard accessories	AC power cable (AC adaptor) x 1, PC software CD x 1 and instruction manual x 1			

Optional Units

Item	Model	Description and Remarks
Battery pack	T2UR18650F5928B	Li-Ion, DC7.4V, 2500mAh. *RM1100 series require two (2) batteries.
Battery charger	NC-LSC05-110V	AC100-110V (50Hz/60Hz) * For charging one battery at a time
	NC-LSC05-220V	AC220-240V (50Hz/60Hz) * For charging one battery at a time
Splash-resistant cover	RM11-402	
Carrying case	RM11-403	
Display arm mount	RM11-405	
SDHC memory card	RM11-452	2GB, industrial use (for saving setting conditions & measured data)
	RM11-453	4GB, industrial use (for saving setting conditions & measured data)
	RM11-454	8GB, industrial use (for saving setting conditions & measured data)
Signal input cable	0311-5175	Length: 2m, insulated BNC connector and alligator clip (+:red, -:black)
	0311-5198	Length: 2m, Insulated BNC connector without clip
	0311-5200	Length: 2m, Insulated BNC connector and metal BNC connector
Logic input cable	0311-5332	Logic IC cord (1pc)
	0311-5337	IC clip cord (4pcs/set)
	0311-5336	alligator clip cord(4pcs/set)
AC/DC voltage detector	1539S	For converting voltage inputs (up to 4) into logic signals H or L
AC voltage level detector	1540S	For pulse output of fluctuation ($\pm 10\%$, $\pm 20\%$) in 100/120V AC
	1543S	For pulse output of fluctuation ($\pm 10\%$, $\pm 20\%$) in 220/240V AC
Voltage output cable	0311-5004	Length: 1.5m, connectors: pin tip and banana plug
Voltage output extension cable	0311-5006	Length: 1.4m, connectors: pin tip and pin tip jack
BNC adaptor	0243-3021	insulated BNC connector and S terminal plug

Current Measuring Devices

Item	Model	Description and Remarks
AC/DC clamp meter	2009R (*1)	for high current (2000A, 400A / DC and 30 to 1kHz, $\phi 55$)
Clamp adaptor	8113 (*2)	for medium current (200A, 20A, 2A / DC to 1kHz, $\phi 19$)
	8112 (*2)	for low current (20A, 2A, 0.2A / 40 to 10kHz, $\phi 8$)
AC/DC clamp sensor	8115 (*2)	for low current (AC130A, DC180A / DC, 40~1kHz, $\phi 12$)
Signal input cable (for clamp meter output)	0311-5184 (*3)	Length: 1.95m, small plug for microphone and insulated BNC

*1: Use signal input cable (0311-5184) if connecting output from 2009R to RM1100

*2: Use a BNC adaptor (0243-3021) if connecting output from 8112, 8113 and 8115 to RM1100

*3: Cable for inputting output from 2009R to isolated BNC connector of RM1100

Inspection Certificate with Data Sheet

Item	Model	Description and Remarks
Inspection Sheet with Data, for RM1101	5694-2063	
Inspection Sheet with Data, for RM1102	5694-2065	

Thermal Printer

Item	Model	Description and Remarks
Thermal printer	RM11-440-B01	For AC100-110V
	RM11-440-C01	For AC220-240V
Standard accessories	AC power cable (AC adaptor) x 1, Recording paper x 1 roll and user's manual x 1	
Battery pack for printer	BP-L0720-A1-E	Li-ion, DC7.4V, 2,000mAh
Battery charger for printer	PWC-L07A1-W1-E	AC100-240V(50/60Hz)
AC power cable for battery charger	CB-US04-18A-E-B	For AC100-110V
	CB-CE01-18B-E-B	For AC220-240V
Cable for printer	0311-5335	Spare cable
Recording paper	YPS118	11.2mm x 25 m roll paper (10 rolls/box)

*Above specifications are subject to change without notice.



Infrared & Measuring Equipment Division

1-5, Nishi-Gotanda 8-chome, Shinagawa-ku,
Tokyo 141-0031 Japan

Phone : +81-3-5436-1614

Fax : +81-3-5436-1395

E-mail : product-irc-e@avio.co.jp

<http://www.avio.co.jp/english/>



WARNINGS & CAUTIONS

Before using this product, please carefully read the provided Operation Manual "WARNINGS" & "CAUTIONS" section to ensure proper operation. Please do not place the product in high temperature, high humidity or high inert gas environments.

Distributor: