

# General Specifications

GX10/GX20  
Paperless Recorder  
(Panel mount type)

**SMARTDAC+**<sup>®</sup>

GS 04L51B01-01EN

Release R4

## OVERVIEW

The GX10/GX20 are paperless recorders that display real-time measured data on a touch screen and save data on an external storage medium (SD card).

For the input/output module specification, please see GX90XA/GX90XD/GX90YD/GX90WD/GX90XP/GX90YA Input/Output Module and GX90UT PID Control Module General Specification (GS 04L53B01-01EN, GS 04L53B01-31EN.)

- The number of analog input is a maximum of 100 channels in GX10 with expandable I/O<sup>\*1</sup>, GM sub unit<sup>1</sup>, a maximum of 100 channels in GX20 standard type (hereafter referred to as "GX20-1") with expandable I/O, and a maximum of 450 channels<sup>\*2</sup> in GX20 large memory type (hereafter referred to as "GX20-2") with expandable I/O, GM sub unit.  
\*1 A unit for expanding the number of channels.  
\*2 Max. number of input/output channels is 500 channels.
- The GX10/GX20 have the large internal memory (GX10/GX20-1: 500MB, GX20-2: 1.2 GB), and prolonged record and preservation are possible.
- As the input signal, a DC voltage, thermocouple, resistance temperature detector, DI (DCV input (TTL), contact signal), mA (DC current), or Pulse input can be set to each channel.
- Analog output is capable of retransmission output of various types of channels and also manual output. It provides current output with channels that are isolated. (Analog output module)
- Input and output have module structure and it can extend them easily. (GX10: max. 3\*, GX20: max. 10\*)  
\* In case of using expandable I/O, GM sub unit, GX10 can extend two units, GX20 can extend 9 units.
- A module type is seven types, an analog input, a analog output, a digital input, a digital output, a digital input/output, a pulse input, and a PID control.
- Up to 6 units of expandable I/O units and GM sub units can be connected to the GX10/GX20. Each expandable I/O and GM sub unit can incorporate a maximum of six modules. With expandable I/O, GM sub unit connected, GX10 and the large memory type GX20 can use multiple channels. Furthermore, the I/O ports can be installed in separate locations from where GX10/GX20 is located, helping you reduce wiring requirements and build a decentralized configuration.
- The intuitive operation by flick, pinch in, and pinch out are possible.
- The past trend under recording can be seamlessly displayed on a trend screen.
- Moreover, the measurement data of the time specified on the calendar screen can be searched and displayed.

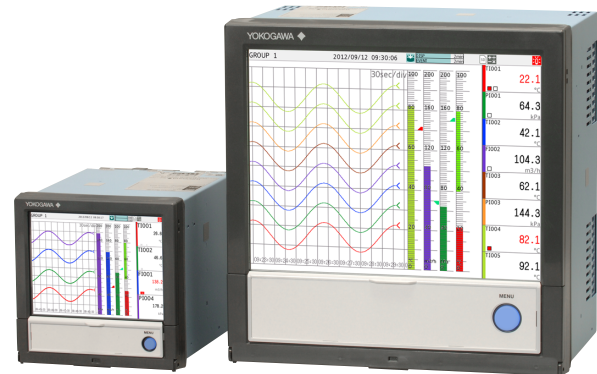

GX10

GX20

- Various functions, such as a freehand message, a PDF/Excel output of a report file, a direct output to a network printer, a scale movement of a trend display, and a buzzer, are equipped.
- It can be hooked up to network via Ethernet, which enables to inform by Email and to monitor on Web site as well as to transfer files by using FTP. Also, it can communicate with Modbus/RTU or Modbus/TCP.
- In high-speed measurement, measurement at the shortest interval of 1 ms is possible by using a high-speed analog input module (high-speed AI).
- In dual interval measurement, measurement can be performed by setting two different scan intervals.
- The PID control function enables PID control on up to 20 loops (6 loops for the GX10/GX20-1) by installing a PID control module.
- The program control function enables program control of up to 99 patterns by using a PID control module and program control function (/PG option). Up to 32 time events and 32 PV events can be set for each segment.

\* For PID control module, PID control function, and program control function (/PG), see the GX90UT PID Control Module General Specifications (GS 04L53B01-31EN)

- \* The contents of this general specifications correspond to the GX10/GX20 with release number 4 and style number 2.  
Release number: firmware ID number  
Style number: hardware ID number

- Various types of computation are possible with the math function (/MT option). The report function enables creation of hourly, daily, and monthly reports and other types of data. Logic math outputs results of computation as 0s or 1s to internal switches and DO channels.
- A setup of GX can be performed on-line from the web browser on PC. A setup by off-line is also possible.
- Universal Viewer software allows a PC to display waveforms on its screen and to print out waveforms.
- The measuring accuracies noted in the general specifications have a margin of error that takes into account the product's components and the equipment used for adjustment and testing. However, the actual values calculated from the accuracy testing data upon shipment of the instrument from the factory are as follows.

Input type		Measuring accuracy *1 (typical value *2)
DCV	20 mV	± (0.01% of rdg + 5 μV)
	60 mV	± (0.01% of rdg + 5 μV)
	6 V (1-5 V)	± (0.01% of rdg + 2 mV)
TC <sup>3</sup>	R	± 1.1 °C
	K	± (0.01% of rdg + 0.2 °C) for 0.0 to 1370.0 °C; ± (0.15% of rdg + 0.2 °C) for -200.0 to 0.0 °C
	K (-200 to 500 °C)	± 0.2 °C for 0.0 to 500.0 °C; ± (0.15% of rdg + 0.2 °C) for -200.0 to 0.0 °C
	J	± 0.2 °C for 0.0 to 1100.0 °C; ± (0.10 % of rdg + 0.2 °C) for -200.0 to 0.0 °C
	T	± 0.2 °C for 0.0 to 400.0 °C; ± (0.10 % of rdg + 0.2 °C) for -200.0 to 0.0 °C
	N	± (0.01 % of rdg + 0.2 °C) for 0.0 to 1300.0 °C; ± (0.22 % of rdg + 0.2 °C) for -200.0 to 0.0 °C
RTD	Pt100	± (0.02% of rdg + 0.2 °C)
	Pt100 (high resolution)	± (0.02% of rdg + 0.16 °C)

\*1 Applies to GX90XA-10-U2, A/D integration time 16.67ms or more, General operating conditions: 23±2 °C, 55±10% RH, supply voltage 90–132, 180–264 VAC, supply frequency within 50/60 Hz ±1%, warm-up of 30 minutes or more, no vibrations or other hindrances to performance.

\*2 For the measuring accuracy (guaranteed), see the module's general specifications (GS04L53B01-01EN).

\*3 These values do not include the reference junction compensation accuracy.  
rdg: reading value.

## ■ MAIN UNIT SPECIFICATIONS

### ■ FUNCTIONAL SPECIFICATION

#### Input/Output Specifications

Please see GX90XA/GX90XD/GX90YD/GX90WD/GX90XP/GX90YA I/O Module and GX90UT PID Control Module General Specifications.

Model	Name	General Specification No.
GX90XA	Analog input module	GS 04L53B01-01EN
GX90DX	Digital input module	
GX90YD	Digital output module	
GX90WD	Digital input/output module	
GX90XP	Pulse input module	
GX90YA	Analog output module	GS 04L53B01-31EN
GX90UT	PID control module	

#### Measuring Functions

- The number of installable modules and I/O channels (total for GX, expandable I/O and GM sub unit)

##### GX10/GX20-1

Item	GX10/GX20-1
Number of module	Max. 10
Number of input/output module	Max. 100

##### GX20-2

Item	GX20-2
Number of module	Max. 45
Number of input/output module	Max. 500 (or max. 450 for AI only)

Module installation limitations:

See "Limitations" and "Notes on Module Installation."

- Expandable I/O, GM sub unit connection\*  
Number of connectable units: Up to 6 units total  
\* Connection is not possible if the measurement mode is set to High speed.  
For details on expandable I/O units and GM sub units, see the respective General Specifications (GS 04L53B00-01EN, GS 04L55B01-01EN).

**Scan interval:**

1, 2, 5, 10, 20, 50, 100, 200, 500 ms, 1, 2, 5 s  
 Note) Some intervals will be unavailable depending on the system configuration and modules.  
 For details, see the I/O Module General Specifications (GS 04L53B01-01EN) and "Limitations" in this manual.

**Measurement mode:**

- Normal  
 A mode in which the shortest measurement interval is 100 ms  
 Number of measurement groups: 1  
 File type: Display data, event data  
 Data format: Binary or text  
 Scan interval: 100 ms (fastest)  
 Compatible modules: All modules
- High speed  
 A mode in which high-speed measurement is possible at the shortest measurement interval of 1 ms  
 Number of measurement groups: 1  
 File type: Event data only  
 Data format: Binary only  
 Scan interval: 1 ms (fastest)  
 Compatible modules: High-speed AI (GX90XA-04-H0), DI (GX90XD), DIO (GX90WD)  
 However, one module, either DI or DIO, can be installed. DI input is fixed to remote mode. Measurement and recording are not possible.
- Dual interval  
 A mode in which measurement is possible by setting different scan intervals on the two measurement groups.  
 Number of measurement groups: 2  
 File type: Event data only  
 Data format: Binary only  
 Scan interval:

Model	measurement group 1	measurement group 2
GX10/GX20-1	5 ms (fastest)	100 ms (fastest)
GX20-2	1 ms (fastest)	100 ms (fastest)

Compatible modules: All modules except PID control module

- \* Depending on the measurement mode, there is a limit to the number of measurement channels and recording channels at scan intervals shorter than 100 ms. See "Limitations."

**Display Functions****Display groups:**

Number of groups; GX10: 30, GX20-1: 50, GX20-2: 60  
 Number of channels that can be assigned to each group; GX10: 10, GX20: 20

**Display color (Trend/Bar graph/Digital display):**

Channel: Select from 24 colors  
 A desired display color can be selected freely using its RGB value.  
 Background: Select from white or black

**Display type:**

- Trend display (T-Y)  
 Display method:  
 Direction: Horizontal, vertical  
 Trend interval (Recording interval): 50 ms/div (1 ms), 100 ms/div (2 ms), 250 ms/div (5 ms), 500 ms/div (10 ms), 1 s/div (20 ms), 2.5 s/div (50 ms), 5 s/div (100 ms), 10 s/div (200 ms), 15 s/div (500 ms), 30 s/div (1 s), 1 min/div (2 s), 2 min/div (4 s), 5 min/div (10 s), 10 min/div (20 s), 15 min/div (30 s), 20 min/div (40 s), 30 min/div (1 min), 1 h/div (2 min), 2 h/div (4 min), 4 h/div (8 min), 10 h/div (20 min)
  - Trend interval shorter than 30 s/div (1 s) cannot be set on electromagnetic relay type analog input modules.
  - Trend interval shorter than 15 s/div (500 ms) cannot be set on low withstand voltage relay type analog input modules.
  - Scan interval shorter than 5 s/div (100 ms) cannot be specified when the measurement mode is set to High speed or Dual interval.
  - On the GX10/GX20-1, scan interval shorter than 250 ms/div cannot be specified in dual interval mode.
- Trend line width: Thick, normal, thin  
 Scale; GX10: Max. 6, GX20: Max. 10  
 Current value bar graph, color scale band, and alarm point marks can be displayed on the scale.  
 A bitmap image scale can be attached.  
 Moving scale; Scale can be moved on any waveform.
- Others; Grid (Auto, 4 to 12), Trip line, Message, Zone display, Partial expanded display
- Historical trend display (T-Y display)  
 Redisplays the display data or event data in the internal memory or external storage medium  
 Time axis operation: The time axis can be reduced or expanded.  
 Data search: Waveforms from the internal memory can be displayed through the specification of a date and time, calendar, each summary  
 All historical trends can be displayed in one screen.
  - Bar graph display  
 Direction: Vertical or horizontal  
 Scale: Display a scale for each channel  
 Color scale band, and alarm point marks can be displayed on the scale.
  - Digital display  
 Displays measured values numerically  
 A DI input state can be displayed as an arbitrary character string (0=Off/1=On, etc.)  
 Update rate: 0.5 s

- **Overview display**  
Display format: All channels, each groups  
Displays the measured values of all channels and the alarm statuses  
Display in groups only when the maximum number of channels that can be displayed (30 on the GX10, 100 on the GX20) is exceeded.
- **Alarm summary display**  
Displays a log of up to 1000 alarms  
Specify an alarm with the cursor and jump to the corresponding section on the historical trend display.
- **Message summary display**  
Time and content of up to 500 messages (simultaneous writing: 450, additional writing: 50)  
Specify a message with the cursor and jump to the corresponding section on the historical trend display.
- **Memory summary display**  
Displays the information (up to 500 (GX10/GX20-1) or up to 1000 (GX20-2) of the data in the memory  
Specify a file with the cursor and jump to the corresponding section on the historical trend display.
- **Report display**  
Displays the report data residing in the internal memory  
For more details, see "MATHEMATICAL FUNCTIONS WITH REPORT FUNCTION (/MT)."
- **Log display**  
Displays the event log, error log, communication log, FTP log, Web log, e-mail log, SNMP log, DHCP log, Modbus log and SLMP log.
- **Multi-panel display (Only for GX20)**  
Divides the screen into two to six sections and displays some different display formats.
- **Internal switch/relay state display**  
Displays the internal switch and ON/OFF state of DO  
Operates the internal switch and ON/OFF state
- **Control screen display (when a PID control module is installed)**  
Control group, control overview, tuning, control summary, control alarm summary, program operation,\* program selection\*  
\* Only when the /PG option is installed
- **Other displays**  
Network information display  
System information display  
System configuration display

#### Auto scroll ON/OFF:

The displayed groups can be automatically switched at a specified interval.  
The display switches in ascending group order.

#### Names of channels:

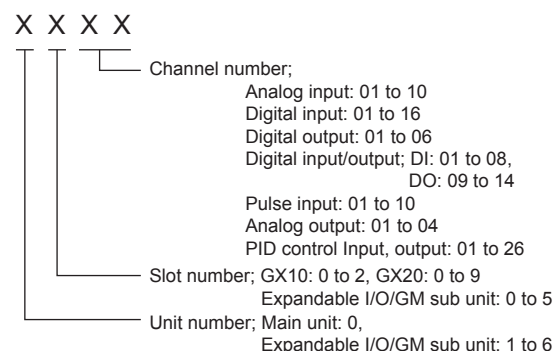

#### Tags:

- Tag and Tag numbers can be displayed.
- Tag number; Number of characters: Up to 16  
Displayable characters: Alphanumeric characters  
Tag numbers can be enabled or disabled.
- Tag; Number of characters: Up to 32  
Displayable characters: Alphanumeric characters

#### Message:

- Write messages to the trend display.
- Number of messages: 100
- Number of characters: Up to 32
- Write method: Write a preset message or write an arbitrary message on the spot.
- Write destination: Select only the displayed group or all groups.
- Auto message: Write a message when the GX recovers from a power failure while memory sampling is in progress.  
Write a message when the trend interval is switched during memory sampling.

#### Add message:

- Write messages to the past data positions.
- Message: The same as the "Message" item above  
Number of writable messages per file: 50 messages (including 10 freehand messages)

#### Freehand message:

- Can be written by dedicated pen.  
Number of writable messages per file: 50 messages (including 10 Add messages)

#### Data Saving Functions

##### Internal memory:

- Temporarily saves various types of data.
- Medium: Flash memory
- File storage capacity;  
GX10, GX20-1: 500 MB  
GX20-2: 1.2 GB

##### External storage medium:

- Medium SD card (SD/SDHC) (up to 32 GB)
- Format: FAT32 or FAT16

##### Data type:

- Display data, Event data, Alarm summary data, Manual sampled data, Screen image data, Setup data, and Report data

**Display data:**

- Target: Measurement (input/output module)/ math/communication channels, alarm summary, message summary  
Description: Maximum or minimum value per recording interval
- Recording intervals: Determined by the trend interval, recording data type (display data/display data + event data, GX20-2)
- Number of channels that can be recorded  
For GX20-1

Trend interval (div)	Number of channels
5 s	100
10 s	200
15 s or longer	500

For GX20-2

Trend interval (div)	Number of channels	
	Display data	Display data + Event data
5 s	200	100
10 s	500	200
15 s	1000	500
30 s or longer	1000	1000

Note that the maximum number of channels is fixed at 100 in the GX10.

- Data size;  
Analog input data: 12 bytes/ch.  
Analog output data: 12 bytes/ch.  
Digital I/O data: 4 bytes/ch.  
Pulse input data: 12 bytes/ch.  
Math channel data: 12 bytes/ch.  
Communication channel data: 12 bytes/ch.
- File size: Up to 18 MB
- Number of files for GX10, GX20-1: Up to 500 (including event data), for GX20-2; Up to 1000 (including event data)  
Operation in the internal memory: FIFO (First In First Out)
- Data format: Binary or text
- Recording: Records data at all times.
- Display data file sample time  
Measurement channel = 30. Math Channel = 0

Internal Memory	500 MB
Trend interval (minute/div)	30 minutes
Recording interval (s)	60 s
Total sample time	Approx. 2.5 years

**Event data:**

- Target: Measurement (input/output module)/ math/communication channels, alarm summary, message summary, operation log  
Description: Instantaneous value per recording interval
- Recording intervals: Determined by the scan interval, recording data type (display data/display data + event data)
- Number of channels that can be recorded:  
Measurement mode: Normal

For GX20-1

Recording interval	Number of channels <sup>*1</sup>
100 ms	100
200 ms	200
500 ms or longer	500

For GX20-2

Recording interval	Number of channels <sup>*1</sup>	
	Display data	Display data + Event data
100 ms	500	100
200 ms	500	200
500 ms	1000	500
1 s or longer	1000	1000

Note that the maximum number of channels is 100 in the GX10.

Measurement mode: High speed

Recording interval	Number of channels <sup>*1</sup>		
	GX10	GX20-1	GX20-2
1 ms	1	2	10
2 ms	4	4	20
5 ms	10	10	50
10 ms	20	20	100
20 ms	40	40	150
50 ms	100	100	150
100 ms	100	100	200
200 ms	100	200	500
500 ms	100	500	1000
1 s or longer	100	500	1000

Measurement mode: Dual interval

Recording interval	Number of channels <sup>*1*2</sup>		
	GX10	GX20-1	GX20-2
1 ms	—	—	5
2 ms	—	—	10
5 ms	5	5	25
10 ms	10	10	40
20 ms	20	20	50
50 ms	50	50	50
100 ms	100	100	100
200 ms	100	100	200
500 ms	100	250	600
1 s or longer	100	250	600

\*1 Total number including I/O channels, PID channels, math channels, and communication channels

\*2 Number of channels that can be recorded is the same for scan group 1 and scan group 2.

- Data size;
  - Analog input data: 6 bytes/ch.
  - Analog output data: 6 bytes/ch.
  - Digital I/O data: 2 bytes/ch.
  - Pulse input data: 6 bytes/ch.
  - Math channel data: 6 bytes/ch.
  - Communication channel data: 6 bytes/ch.
- File size: Up to 18 MB
- Number of files for GX10, GX20-1: Up to 500 (including display data), for GX20-2; Up to 1000 (including display data)
- Operation in the internal memory: FIFO (First In First Out)
- Data format: Binary or text
- Mode; Free: Records data at all times.
  - Trigger: Starts recording data when a certain event occurs and records for the specified interval.
  - Repetition trigger: Repeat Trigger mode
- Event data file sample time  
Measurement channel = 30. Math Channel = 0

Internal Memory	500 MB
Recording interval (s)	1 s
Total sample time	Approx. 1 month

### Alarm Functions

- Number of alarms: Up to four alarms (level) for each measurement channels
- Alarm type: High limit, low limit, difference high limit, difference low limit, high limit on rate-of-change alarm, low limit on rate-of-change alarm, delay high limit, and delay low limit
- Alarm delay time: 1 s to 24 hours (for each channel)
- Rate-of-change calculation interval of rate-of-change alarms: 1 to 32 times the scan interval (common to all channels)
- Hysteresis: 0.0 to 5.0% of the span (for each alarm (level))
- Alarm output: Output to the internal switch, relay  
Internal switch/relay operation: AND/OR operation selectable
- Display: Displays the status on the respective operation screen and an alarm icon on the status display section when an alarm occurs.  
Display operation: Hold or not hold the display until the alarm acknowledge operation
- Alarm hide function (alarm no logging function)  
Used for relay and internal switch output and events of event action and not recorded in alarm display or alarm summary (each channel)
- Alarm information: Displays a log of alarm occurrences on the alarm summary
- Reflash: The duration for which the reflash relays are deactivated can be set to 500 ms, 1 s, or 2 s.
- Individual alarm ACK function:  
Alarm display and relay output can be cancelled on individual alarms

### Event Action Functions

- Event action: Execute a specified operation when a given event occurs.
- Number of settings: 50  
Events: Remote control input, etc.  
Number of timers: 12  
Number of match time timers: 12  
Action: Specify memory start/stop, alarm ACK, etc.

### Control Event Action Functions

See GX90UT PID Control Module General Specifications (GS 04L53B01-31EN).

### Security Functions

- Operation lock function: Limitations to touch operation, access to the external storage medium, and various operations
- Login function: Only registered users can operate the GX.  
It can be set to each of touch operation and communication access.  
System administrators and Users: 50 (totally)  
Number of Authority of user: 10 level

### Manual Sampled Data

- Item: Instantaneous value at an arbitrary time
- Target: Measurement (input/output module)/math/communication channels
- Number of recording channels;  
GX10, GX20-1: Max. 50  
GX20-2: Max. 100
- Maximum number of data values that the internal memory can store: 400
- Data format: Text

### Report Data

- Item: Report at each scheduled time of report
- Target: Measurement (input/output module)/math/communication channels
- Maximum number of reports that the internal memory can store: 800
- Data format: Text

### Snapshot Data

- Item: Displayed screen image data
- Data format: PNG
- Output destination: External medium or communication output

### Setup Data

- Item: GX setup data
- Data format: Text
- Output/read destination (for saving/loading):  
External medium

### Clock Functions

- Clock: With a calendar function
- Accuracy:  $\pm 5$  ppm (0 to 50°C), excluding a delay (of 1 second, maximum) caused each time the power is turned on.
- Time difference between units:  $\pm 2$ ms max. (time difference between a GX and I/O Base Unit (Expandable I/O))

- Time setting: Using touch operation, communication command, event action function, or SNTP client function
- Time adjustment method:  
Limit in which the time is gradually adjusted: Select from the available settings between 5 s and 15 s.  
Whether to change an out-of-limit operation immediately or report it as an error can be selected.  
While memory sampling: Corrects the time by 1 ms for each second.  
While memory is stopped: Immediately change the time.
- DST: The date/time for switching between standard time and DST can be specified.
- Time zone: Sets the time difference from GMT.
- Date format: Select "YYYY/MM/DD", "MM/DD/YYYY", "DD/MM/YYYY" or "DD.MM.YYYY".  
MM expression can be selected from the numeric character or ellipsis. Ex. January: 01 or Jan  
The delimiter can be selected from "/", ".", "-".
- Modbus client\*: Reads data from another device and writes to the registers.  
Number of connectable sever;  
GX10, GX20-1: Max. 16  
GX20-2: Max. 32  
\*: Required /MC option
- Modbus server: Loads measurement and math channel data  
Loads and writes communication channel data  
Some control commands such as memory start Modbus client\* register access limitations  
\*: Required /MC option  
Number of the simultaneous connection: Max. 4
- Setting/Measurement server: Operate, set, and output data of the GX using a dedicated protocol.  
Number of the simultaneous connection: Max. 4
- DARWIN compatible communication server: Supports some DARWIN commands  
Communication with GX is possible using DARWIN communication commands.
  - Output-related commands: Output measurement (IO) channel data, Output calculation channel data, Output relay status, Output the position of the decimal point for the measurement (IO) channel, Output the position of the decimal point for the calculation channel, Output the information on system configuration
    - Setup-related commands: Range, Scale unit, Alarm, Time, Moving average, zone
    - Operation-related commands: Reset alarm, Reset timer, Start MATH calculation, Rebuild system, Initialize, Input communication, Output communication DO, Write message

### Ethernet Communication Functions

- Electrical specifications: Conforms to IEEE 802.3
- Connection: Ethernet (10BASE-T/100BASE-TX)
- Max. segment length: 100 m
- Max. connecting configuration: Cascade Max. 4 level (10BASE-T), Max. 2 level (100BASE-TX)
- Connector: RJ-45
- Protocols: TCP, UDP, IP, ICMP, ARP, DHCP, HTTP, FTP, SMTP, SNTP, Modbus, and dedicated protocols
- E-mail client: Automatically send e-mail at specified times.  
E-mail is sent by events as below.
  - Alarm occurring/alarm canceling (Max. 50ch)
  - Recover from power failure
  - Report data generating
  - Storage medium error, FTP client function error
  - Specified time period
 POP before SMTP and SMTP authentication (PLAIN and CRAM-MD5) is available.
- FTP client: Automatically transfer data files to the FTP server.  
Applicable files: Display data, event data, screen image data, report data, etc.
- FTP Server: Transfer files, delete files, manipulate directories, and output file lists of the GX.  
Number of the simultaneous connection: Max. 4
- Web server: Web application, GX real-time monitoring and setting changes/operations can be performed with the Web browser.  
The screen layout can be determined independently of the screen of the GX main unit.  
Number of the simultaneous connection: Max. 4
- SNTP client: Inquires the time to the SNTP server and sets the GX.
- SNTP server: Outputs the GX time.  
Time resolution: 5 ms
- DHCP client: Automatically obtain the network address settings from the DHCP server.

### Batch Function

- Function: Data management using batch names.  
Enter text fields and batch comments in the data file.
- Batch name: Added to the file name of the display data and event data.  
Structure: Batch number (up to 32 characters) + lot number (up to 8 digits)  
Use/not use selectable for lot number, on/off selectable for auto increment function.
- Text field: Adds text to the display data and event data.  
There are 24 available text fields.  
Up to 20 title characters and 30 other characters can be entered per field.
- Batch comment: Adds text to the display data and event data.  
3 comments (max. 50 characters) are available.

### Printer Output Function

- Snapshot Data can be printed out with any LAN-connected printer supporting the HP PCL5c language and the port 9100.

## SSL Communication Functions

Communication that sends and receives information encrypted by the SSL (Secure Socket Layer) protocol is possible.

- Server function:  
Supported servers: HTTP server and FTP server (Port number: 443 when encryption is used)  
Private key: Created in GX and saved in the internal memory  
Server certificate: Server certificates created by users can be saved in the internal memory.  
Self-signed certificates can be created in GX.
- Client function:  
Supported clients: FTP client (only Explicit mode is supported) and SMTP client (only STARTTLS is supported)  
Trusted certificate: Trusted certificates (a total of up to 80 KB) can be saved in the internal memory.

## Electronic Signature Function

Electronic signatures can be added to report files created in PDF format using the PDF form creation function. An electronic signature is provided each time a report file is created.

- Certificate for electronic signature: Certificates for electronic signatures created by users can be saved in the internal memory.

## Loop Control Function (with PID control module)

See GX90UT PID Control Module General Specifications (GS 04L53B01-31EN).

## Other Functions

- Buzzer: GX makes a buzzer sound at touch screen operation, or when alarm occurs.
- Backlight saver function: Dim or turn off the LCD backlight if there is no key operation for a specified time.
- Favorite display: Register frequently used displays to the Favorite and show them through simple operation.
- The main alarm is indicated using the MENU key LED.  
No alarm: Blue (same condition as power-on)  
Alarm condition: Red.
- User function feature: A button (user function key) to which the user can assign a desired function is provided. It can be assigned to an event triggered by the event action function.
- Firmware update function: The Web application, the IO module, or the expansion module firmware can be updated by operating GX.

## HARDWARE SPECIFICATIONS (MAIN UNIT)

### Display

#### Display unit\*:

GX10: 5.7-inch TFT color LCD (640 × 480 dots)  
GX20: 12.1-inch TFT color LCD (800 × 600 dots)

\* A small number of missing or steady-on LCD pixels and minor variations in brightness uniformity is a normal display characteristic and not a malfunction.

#### Touch screen:

4 wire resistive touch screen

### Construction

- Mounting: Flush panel mounting (on a vertical plane)
- Mounting angle: Inclined backward up to 30 degrees from a horizontal plane. Left and right horizontal
- Panel thickness: 2 to 26 mm
- Material;  
Case: Metal plate  
Bezel and display cover: Polycarbonate
- Color;  
Case: Smoke blue (Munsell 4.1PB6.0/4.5 equivalent)  
Bezel: Charcoal grey light (Munsell 10B3.6/0.3 equivalent), front door: Light grey (Munsell 5.2PB8.2/1.0 equivalent)
- Front panel: Water and dust proof: Complies with IEC529-IP65 and NEMA No.250 TYPE 4 (except External Icing Test), except for side-by-side mounting
- External dimensions:  
When installing modules  
GX10: 144(W) × 144(H) × 255(D) mm  
GX20: 288(W) × 288(H) × 220(D) mm  
When uninstalling modules  
GX10: 144(W) × 144(H) × 174(D) mm  
GX20: 288(W) × 288(H) × 169(D) mm  
(D: depth from the panel mounting plane)
- Weight:  
GX10: Approx. 2.1 kg, GX20: Approx. 6.0 kg (excluding modules)

### Power Supply

- Rated supply voltage: 100 to 240 VAC
- Allowable power supply voltage range: 90 to 132, 180 to 264 VAC
- Rated power supply frequency: 50/60 Hz
- Power consumption:

Supply voltage	LCD backlight off	Normal operation	Maximum
100 V AC	GX10: 16 VA GX20: 28 VA	GX10: 20 VA GX20: 34 VA	GX10: 48 VA GX20: 90 VA
240 V AC	GX10: 24 VA GX20: 38 VA	GX10: 30 VA GX20: 45 VA	GX10: 60 VA GX20: 110 VA

\* The following combinations are assumed for LCD backlight off and normal operation.

GX10: 1 AI module, 1 DO module, 1 DI module  
GX20: 5 AI modules, 4 DO modules, 1 DI module

- Module power supply voltage: The total allowable power consumption of respective modules is up to 6 W in the GX10 and up to 20 W in the GX20.



- Allowable interruption time: Less than 1 cycle of the power supply frequency

### Isolation

- Insulation resistance: Between the Ethernet, RS-422/485, and each insulation terminals and earth: 20 MΩ or greater at 500 VDC
- Withstand voltage:  
Between the power terminal and earth: 3000 V AC at 50/60 Hz for one minute  
Between the contact output terminal and earth: 3000 V AC at 50/60 Hz for one minute  
Between the input/output modules and earth: Depends on the specification of I/O module.
- Grounding: Be sure to set a low grounding resistance.
- Isolation:

Power terminal	FAIL output terminal	Internal circuit
	Ethernet port	
	RS-422/485 terminal	
	Input and output module terminal	
	Input and output module internal circuit	
	Earth (PE) terminal	
	RS-232 terminal	
	SD card slot	
	USB port	

The circuits divided by lines are insulated mutually.

### Safety and EMC Standards

- CSA:  
CAN/CSA22.2 No.61010-1, installation category II<sup>\*1</sup>, pollution degree 2<sup>\*2</sup>  
CAN/CSA-C22.2 NO. 61010-2-030  
CAN/CSA-IEC 61010-201<sup>\*4</sup>
- UL:  
UL61010-1, UL 61010-2-030 (CSA NRTL/C)  
UL61010-2-201 (CSA NRTL/C)
- CE/EMC directive:  
EN61326-1 compliance, Class A Table 2  
EN61000-3-2 compliance  
EN61000-3-3 compliance  
EN55011 Class A Group 1
- CE/Low voltage directive:  
EN61010-1, EN 61010-2-030  
Installation category II<sup>\*1</sup>  
Pollution degree 2<sup>\*2</sup>  
Measurement category<sup>\*3</sup>  
EN61010-2-201<sup>\*4</sup>
- EMC Regulatory Arrangement in Australia and New Zealand (RCM): EN55011 compliance, Class A Group 1
- KC marking: Electromagnetic wave interference prevention standard, electromagnetic wave protection standard compliance

\*1 Installation category (overvoltage category) II:  
Describes a number which defines a transient overvoltage condition.  
Implies the regulation for impulse withstand voltage.  
“II” applies to electrical equipment which is supplied from the fixed installation like a distribution board.

- \*2 Pollution degree 2:  
Describes the degree to which a solid, liquid, or gas which deteriorates dielectric strength or surface resistivity is adhering.  
“2” applies to normal indoor atmosphere.  
Normally, only non-conductive pollution occurs.
- \*3 Measurement category: Depends on the specification of each modules
- \*4 This product is designed as open equipment under the relevant standard, install it as follows:  
• The GX10/GX20 is designed to be installed in an instrumentation panel.  
Install it in a location where people cannot touch the terminals carelessly.  
• Install the GX60/GM unit in a panel with a door.  
• The instrumentation panel or panel used for support must comply with CSA/UL/EN 61010-2-201 or must be at least IP1X (degrees of protection) and at least IK09.

Category	Measurement category	Description	Remarks
II	CAT II	Available in the testing and measuring circuits directly connected to a usage location (receptacle or the like) of a low-voltage main power supply facility.	Appliances, portable equipment, etc.
III	CAT III	Available in the testing and measuring circuits connected to a power distribution portion of a low-voltage main power supply facility.	Distribution board, circuit breaker, etc.
IV	CAT IV	Available in the testing and measuring circuits connected to a power source of a low-voltage main power supply facility.	verhead wire, cable systems, etc.

### Normal Operating Conditions

- Power supply voltage: 100 to 240 V AC ±10 %
- Power supply frequency: 50/60 Hz ±2 %
- Ambient temperature: 0 to 50 °C
- Ambient humidity: 20 to 80 %RH (at 5 to 40°C) (no condensation)
- Magnetic field: 400 A/m or less (DC and 50/60 Hz)
- Vibration:  
5 ≤ f < 8.4 Hz amplitude 3.5 mm (peak)  
8.4 ≤ f ≤ 160 Hz acceleration 9.8 m/s<sup>2</sup>
- Shock:  
Non-energization, 500 m/s<sup>2</sup> or less, approximate 10 ms, 6 directions (±X, ±Y, ±Z), 3 times in each direction
- Mounting position: Can be inclined up to 30 degrees backward. Left and right horizontal when installing the panel mount and wall mount.
- Altitude: 2000 m or less
- Installation location: Indoors
- Warm-up time: At least 30 minutes after power on

**Other Specifications**

- Memory backup: A built-in lithium battery backs up the settings and runs the clock
- Recommended replacement periods of Battery: Approximately 10 years (at room temperature)

**Transport and Storage Conditions**

- Ambient temperature: -25 to 60°C
- Ambient humidity: 5 to 95 %RH (no condensation)
- Vibration: 10 to 60 Hz, 4.9 m/s<sup>2</sup> maximum
- Shock: 392 m/s<sup>2</sup> maximum (in packaged condition)

**EXTERNAL DIMENSIONS AND PANEL CUTOUT DIMENSIONS**

**GX10:**

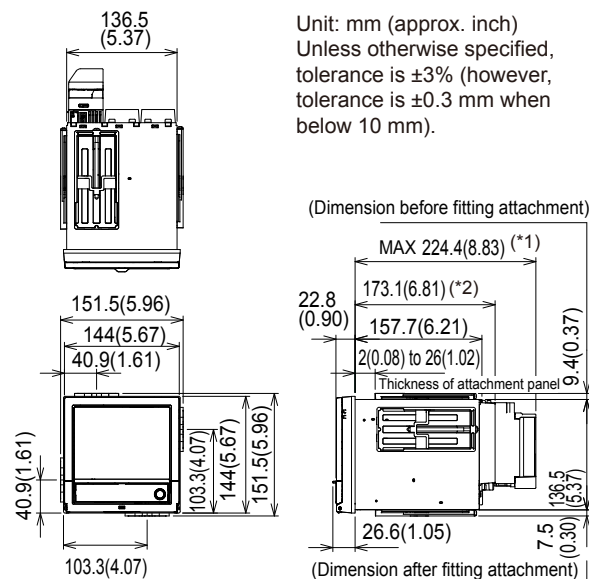

**Panel cut dimensions**

**Single-Unit Mounting**

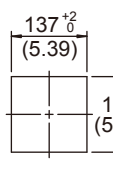

**Side-by-Side Mounting (horizontally)**

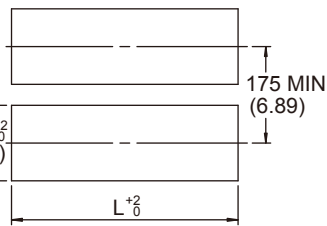

**Side-by-Side Mounting (vertically, max. 3 units)**

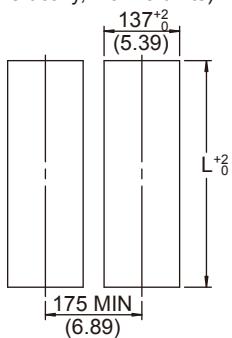

Units	L <sup>+2/0</sup>
2	282 (11.10)
3	426 (16.77)
4	570 (22.44)
5	714 (28.11)
6	858 (33.78)
7	1002 (39.45)
8	1146 (45.12)
9	1290 (50.79)
10	1434 (56.46)
n	(144×n)-6

**Rear view**

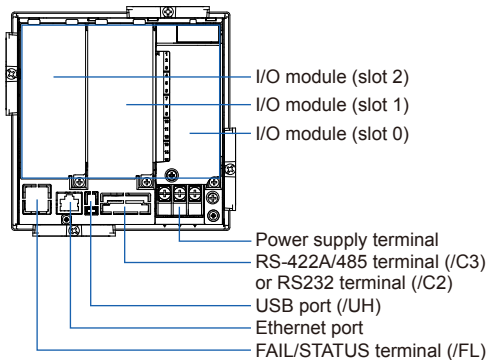

**GX20:**

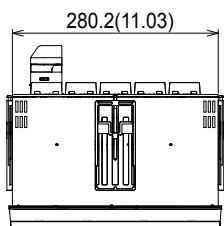

Unit: mm (approx. inch)  
 Unless otherwise specified, tolerance is  $\pm 3\%$  (however, tolerance is  $\pm 0.3$  mm when below 10 mm).

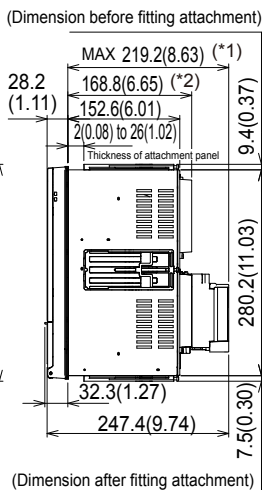
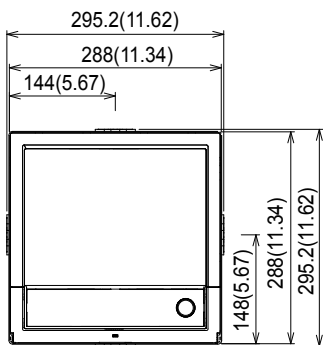

\*1: with modules  
 \*2: without modules

**Panel cut dimensions**

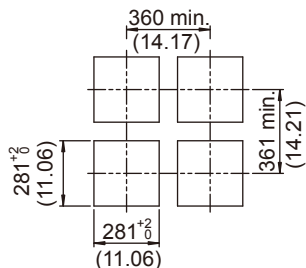

**Rear view**

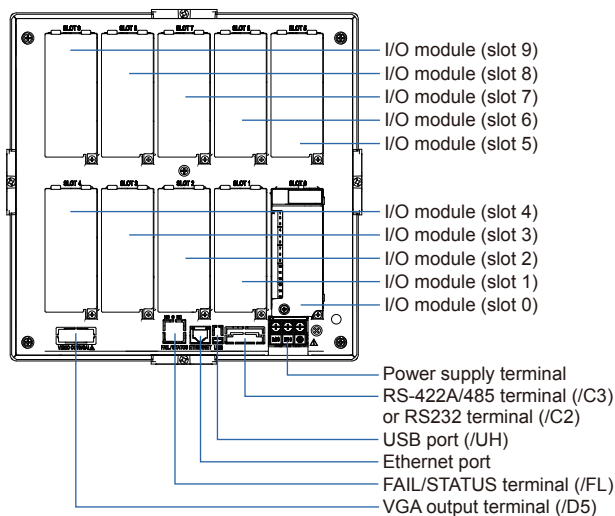

**Precautions to Be Taken While Wiring**  
 With a screw terminal, we recommend that you use a crimp-on lug with an insulation sleeve (M4 for power supply wiring, M3 for signal wiring).  
 Recommended signal wiring crimp-on lug  
 N1.25-MS3 (JST Mfg. Co., Ltd.)

**■ SPECIFICATIONS OF OPTIONAL FUNCTIONS**

**ADVANCED SECURITY FUNCTION (/AS)**

Security and electronic record/signature functions have been added that are compliant with the USA's FDA title 21 CFR Part 11.

- Enabling/disabling the advanced security function:  
 You can enable or disable the advanced security function.

\* The set values and data stored in the internal memory are initialized each time the function is enabled or disabled.

- Data anti-tamper function:  
 Settings and measured data are saved as encrypted binary files.
- Data type:  
 Only for display or event  
 Trigger mode is not possible with event data.
- Login function:  
 Using the login function described below, you can enter security settings on the instrument
  - User name
  - Password
  - User ID (depend on setting)
  - User level and number of users:  
 System administrator (all can be operated), General user (With user restrictions, you can set restrictions on performing operations and sign authority.), Monitor user (monitoring only), totally 100 users
  - User restrictions setting: 10 kinds (for general users)

- Password expiration time:  
 select form Off, 1month, 3 month, 6month
- Password control function:  
 Logins are verified by a Kerberos v5 authentication server\* (only user name and password)

Encryption method:  
 AES128-CTS-HMAC-SHA1-96  
 AES256-CTS-HMAC-SHA1-96  
 ARCFOUR-HMAC-MD5

Pre-Auth function: use

- \* The function has confirmed compatibility with Windows Server2003 SP2/Windows Server2008 SP2/Windows Server2012 ActiveDirectory
- Signature function:  
 After checking data that has finished being recorded, you can add three levels of electronic signature, select a pass/fail, and enter comments (50 characters maximum)
- Audit trail function:  
 The operation log, the settings change log and the settings file when the change was made are saved.
- Measurement mode limitations  
 High speed and Dual interval measurement modes are not supported.
- Module limitations  
 PID control modules are not supported.

## SERIAL COMMUNICATION INTERFACE (/C2, /C3)

- Connection: EIA RS-232(/C2) or EIA RS-422/485(/C3)
- Protocol: Dedicated protocol, Modbus/RTU, or DARWIN compatible communication
- Setting/measurement server function: Operation, setting or output of measurement data are available by dedicated protocol.
- Synchronization: Start-stop synchronization
- Transmission mode (RS-422/485):  
RS-422: Four-wire half-duplex multi-drop connection (1:n (n = 1 to 31))  
RS485: Two-wire half-duplex multi-drop connection (1:n (n = 1 to 31))
- Baud rate: 1200, 2400, 4800, 9600, 19200, 38400, 57600, or 115200 bps
- Data length 7 or 8 bits
- Start bit: 1 bit
- Stop bit: 1 bit or 2 bit
- Parity: ODD, EVEN, or NONE
- Handshaking Off: Off, XON: XON, XON: RS, and CS: RS
- Communication distance;  
RS-422/485: 1200 m (57600 bps or less), 600 m (115200 bps)  
RS-232: 15 m
- Modbus/RTU communication: Reading or writing of measurement data on other instruments is available by Modbus protocol.  
Communication channel function option (/MC) is needed to read measurement data from other instruments.
- Operation modes: Master or slave
- Execution of a communication command using a bar code: The entered text can be executed as a communication command.

## CUSTOM DISPLAY (/CG)

Using DXA170 DAQStudio, screen creation software, a custom screen can be constructed and displayed in which display components (such as trend, digital, and bar graphs) are freely placed. The screen data is transferred from DAQStudio to the internal memory via communication, or loaded from an external medium to the internal memory and displayed.

- Number of screens: 30 (internal memory)
- Display components:
  - Normal components (digital value, bar graph, tag No., tag comment, simple digital value, simple bar graph, alarm mark, unit, alarm indicator, lower-limit span value, upper-limit span value, group name, system icon, memory sample bar, date/time view, batch name, and user name)
  - Trend components (trend group display (with scale board))
  - List components (alarm list view and message list view)
  - Operation components (DO (DO operable), internal switch (internal switch operable), numeric value operations (viewing data of and writing data to communication channels), and button operations (writing numeric values, operating bits, switching screens, and executing communication commands))

- Text components (labels)
- Figure components (line view, rectangle view, and circle view)
- Image components (PNG image data)
- Batch components (Batch number, Lot number, Text field, Batch comment, Batch group number\*)
- \* Only on GX with the Multi batch function (/BT option)
- Control component (controller, control alarm indicator, external controller)
- Configuring screens: Screen creation software Creation using DXA170 DAQStudio (GX does not have a creation function)
- Saving/loading screen data:  
A specified screen or all the screens is/are loaded from an external storage medium to the internal memory, or a specified screen or all the screens in the internal memory is/are saved on an external storage medium.

## VGA VIDEO OUTPUT (/D5) (Only for GX20)

- External display:  
Resolution: 800 × 600 dots (VGA)  
Connector: 15-pin D-Sub (female)

## EtherNet/IP COMMUNICATION (PLC communication protocol) (/E1)

Can be joined to an Ethernet/IP network as an adapter (or a server).

- Loading data from the I/O channel or calculation channel (/MT)  
I/O channel:  
GX10: 100, GX20-1: 100, GX20-2: 500  
Calculation channel:  
GX10: 50, GX20-1: 100, GX20-2: 200
- Loading and writing data from/to the communication channel (/MC)  
Communication channel:  
GX10: 50, GX20-1: 300, GX20-2: 500
- Implementation level: Level 2
- Supported protocols: EIP/PCCC, EIP/native
- Number of the simultaneous connection: Max. 10 (Explicit message)

## WT COMMUNICATION (/E2)

Collects data by connecting to WT equipment manufactured by Yokogawa Meters & Instruments Corp. via Ethernet communication\*.

\* The /MC option is required.

- Supported models: WT1800E (command type WT1800), WT1800, WT300E (command mode WT300). WT500, and WT300
- Number of connectable units:  
GX10: 8  
GX20: 16
- Communication cycle: 500 ms/1 s/2 s/5 s/10 s/20 s/30 s
- Types of data that can be obtained: Voltage, current, power, power factor, phase, electrical energy, high-frequency wave, etc.
- Number of data allocations  
GX20: 300  
GX10: 50

## FAIL OUTPUT (/FL)

- Contact: C contact, 1 point
- FAIL output:  
The relay contact output on the rear panel indicates the occurrence of CPU failure.  
Relay operation: Energized during normal operation and de-energized on CPU failure.
- Status output: The relay contact, which is de-energized in normal output state, is energized upon the occurrence of a memory/media error, measurement error, communication error, recording stop, or alarm.
- Rated power supply voltage: 24 V DC or 250 V AC or less
- Rated load current: 3A (DC)/3A (AC), resistance load
- Min. load current: 100 mA
- Recommended replacement periods of contact:  
Electrical: 30,000 more ON-OFF operations,  
Mechanical: 5,000,000 more ON-OFF operations

## Log SCALE (/LG)

A logarithmic voltage that has been converted from a physical value is applied to the GX, and then the GX's Log scale (logarithmic scale) is used to display and record the physical value.

- Input type: Log input (logarithmic input), Pseudo log input: An input that supports pseudo logs, Log linear input: Input that is linear on a logarithmic scale.
- Range: 20mV/60mV/200mV/1V/2V/6V/20V/50V/100V
- Scalable range:
  - Log input:  
1.00E-15 to 1.00E+15 (15decade maximum)  
Scale\_L < Scale\_U  
If the lower limit mantissa is 1.00, the difference between the exponents must be 1 or more.  
If the lower limit mantissa is a value other than 1.00, the difference between the exponents must be 2 or more.
  - Pseudo Log Input/Log linear input  
1.00E-15 to 1.00E+15 (15decade maximum)  
The higher limit mantissa is the same as the lower limit mantissa).  
If the lower limit mantissa is 1.00, the value must be between 1.00E-15 and 1.00E+15, the difference between the exponents must be 1 or more, and the maximum decades is 15.  
If the lower limit mantissa is a value other than 1.00, the value must be between 1.01E-15 and 9.99E+14, the difference between the exponents must be 1 or more and the maximum decades is 15.
- Alarm type: High limit, low limit, delay high limit, and delay low limit
- Alarm setting range: The range converted into the LOG scale corresponding to -5% to 105% of the span width.
- Alarm hysteresis: Fixed to 0

- Green band setting range: The lower limit to the upper limit of the scale. However, the lower limit of the display position must be smaller than the upper limit.
- Position of the decimal point: 1 to 2
- Misc: Nonlinear input is possible by correcting the input value

## MATHEMATICAL FUNCTIONS WITH REPORT FUNCTION (/MT)

### Mathematical Function:

- Number of math channels; GX10: 50, GX20-1: 100, GX20-2: 200

Note) Note: Depending on the measurement mode, there is a limit to the number of math channels at scan intervals shorter than 100 ms. See "Limitations."

- Scan interval

Measurement mode	Scan interval
Normal	Scan interval
High speed	Scan interval
Dual interval	Master scan interval*

- \* When the measurement mode is Dual interval, this item sets which scan interval to use, the interval of measurement group 1 or that of scan group 2, for creating measured values of math or communication channels and other similar operations.
- Number of expressions:
- Operation:  
General arithmetic operations: Four arithmetic operations (+, -, \*, /), square root, absolute, common logarithm, natural logarithm, exponential, and power  
Relational operations: <, ≤, >, ≥, =, and ≠  
Logic operations: AND, OR, NOT, and XOR  
Statistical operations: TLOG (maximum, minimum, average, sum, P-P values of time series data) or CLOG (maximum, minimum, average, sum, P-P values of a specified channel)  
Special operations: PRE, HOLD, RESET, and CARRY  
Conditional operation: [a?b:c]  
Bit operation: BIT  
Integer extracting operation: INT  
Remainder extracting operation: MOD  
Trigonometric functions: SIN, COS  
CP operations: CP.02, CP.CO2
- Computation accuracy: Double-precision floating point
- Data that can be used;  
Channel data: Measurement channels (0001 to 6516), mathematical channels (GX10: A001 to A050, GX20-1: A001 to A100, GX20-2: A001 to A200), Communication channels (GX10: C001 to C050, GX20-1: C001 to C300, GX20-2: C001 to C500), Communication channels raw data (GX10: RC001 to RC050, GX20-1: C001 to C300, GX20-2: RC001 to RC500), Constants:-K001 to K100, Variable constant: W001 to W100, Internal switch: S001 to S100, Flag: F01 to F20, Recording state (REC01), Magic number math data: Z000 to Z999

**Logic math function:**

A function that outputs calculated results as 0 or 1 to DOs or internal switches

- Number of logic calculations maths:  
GX10: 20, GX20-1/GX20-2: 50
- Expression: Up to 120 characters
- Computation type: Basic arithmetic, relational, logical, conditional, bit
- Data that can be used: All channel data
- Logic math: LM001 to LM020 (GX10), LM001 to LM050 (GX20-1/GX20-2)
- Output destination: DO channels, internal switches (only when set to Manual in either case)
- Setting change: Cannot be changed during recording or control
- Math interval: 100 ms (fastest)

**Report function:**

- Number of report channels; GX10: 50, GX20: 60

Note) Depending on the measurement mode, there is a limit to the number of report channels at scan intervals shorter than 100 ms. See "Limitations."

- Scan interval

Measurement mode	Scan interval
Normal	Scan interval
High speed	Scan interval
Dual interval	Scan interval of each measurement group

- Report types: Hourly + daily, daily + weekly, daily + monthly, Batch, Day custom
- Computation types: Average, maximum, minimum, sum, or instantaneous value
- Unit of sum: OFF, /s, /min, /hour, /day
- Report templates: Office Open XML spreadsheet files (which can be displayed with Microsoft Office Excel) or PDF files can be output or printed out with any LAN-connected printer supporting the HP PCL5c language and the port 9100.

**COMMUNICATION CHANNEL FUNCTIONS (/MC)\***

- Number of communication channels;  
GX10: 50 (C001 to C050)  
GX20-1: 300 (C001 to C300)  
GX20-2: 500 (C001 to C500)

Note) Depending on the measurement mode, there is a limit to the number of communication channels at scan intervals shorter than 100 ms. See "Limitations."

- Scan interval

Measurement mode	Scan interval
Normal	Scan interval
High speed	Scan interval
Dual interval	Master scan interval

\* Required to record data from EtherNet/IP (/E1), Modbus devices, or PCs on the GX and to write data in the remote device from the GX via Modbus.

**24 V DC/AC POWER SUPPLY (/P1)**

- Rated power supply: 24 V DC/24 V AC (50/60 Hz)
- Allowable power supply voltage range: 21.6 to 26.4 V DC/AC
- Insulation resistance: 20 MΩ or greater at 500 V DC between power terminal and earth
- Withstand voltage: 500 V AC at 50/60 Hz for one minute between power terminal and earth
- Rated power supply frequency (for AC): 50/60 Hz
- Allowable power supply frequency (for AC): 50 Hz  $\pm$  2%, 60 Hz  $\pm$  2 %
- Influence of power supply voltage variation: Variations of the measured value must be within  $\pm$ 1 digit in the range from 21.6 to 26.4 VAC/VDC.
- Influence of power supply frequency variation (for AC): Variations of the measured value must be within  $\pm$ (0.1% of rdg + 1 digit) at a rated frequency of  $\pm$ 2 Hz.
- Power consumption:

Supply voltage	LCD backlight off	Normal operation	Maximum
24 V DC	GX10: 7 VA GX20: 13 VA	GX10: 9 VA GX20: 16 VA	GX10: 24 VA GX20: 48 VA
24 V AC	GX10: 14 VA GX20: 25 VA	GX10: 17 VA GX20: 29 VA	GX10: 42 VA GX20: 76 VA

\* The following combinations are assumed for LCD backlight off and normal operation.

GX10: 1 AI module, 1 DO module, 1 DI module  
GX20: 5 AI modules, 4 DO modules, 1 DI module

- Module power supply voltage: The total allowable power consumption of respective modules is up to 6 W in the GX10 and up to 20 W in the GX20.

**USB INTERFACE (/UH)**

- USB port: Complies with USB 2.0 and host function
- Number of ports: 2 (one each on the front panel and rear panel)
- Connectable devices: Only connect the devices listed below to prevent damage to the devices.
  - Keyboard: Complies with HID Class Ver. 1.1 104/89 keyboard (US) and 109/89 keyboard (Japanese)
  - Mouse: Complies with HID Class Ver. 1.1
  - External medium: USB flash memory  
Does not guarantee the operation of all USB flash memories  
External medium such as a hard disk, ZIP, MO, and optical discs are not supported.
  - Barcode reader: USB HID Class Ver. 1.1 compatible  
English (U.S.) standard USB keyboard compatible
- Execution of a communication command using a bar code: The entered text can be executed as a communication command.
- Power supply: 5 V  $\pm$  10%, 500 mA \*1

\*1: Devices which need more than 500 mA total bus power for 2 ports cannot be connected at the same time.  
For low powered devices (bus power < 100 mA):  
5V  $\pm$  5%  
For high powered devices (bus power < 500 mA):  
5V  $\pm$  10%

**BLACK COVER (/BC)**

Front door color: Charcoal grey light (Munsell 10B3.6/0.3 equivalent)

**AEROSPACE HEAT TREATMENT (/AH)**

Supports heat treatment application AMS2750/ NADCAP.

Schedule management for periodically executing calibration correction configuration and the like.

In correction coefficient mode of calibration correction, two biases can be specified: one based on thermocouple and another based on device

- Number of manageable schedules  
GX20-1:6  
GX20-2: 12
- Calibration correction mode:  
Off, Linearizer approximation, Linearizer bias, correction factor
- Number of set points: 2 to 12
- Notification contents  
Title, Notification message, Due date  
Notification buzzer can be sounded.

**MULTI-BATCH FUNCTION (/BT)**

Recording start/stop and data file creation is possible for each batch.

- Number of multi-batches:  
GX10/GX20-1: max. 6, GX20-2: max. 12
- Batch single operation: Memory start/stop, math reset, message writing
- Batch overview operation: Computation start/stop, report start/stop, manual sampling, setup data save/load
- Scan interval: 500ms, 1 s, 2 s, 5 s (common to all batches)
- Data type: Display or event only Trigger mode not available for event data.
- Recording interval: Common to all batches
- Data file: Display or event data file created for each batch
- Number of display groups:  
GX10: 6 max. per batch  
Number of channels per group: 10  
GX20-1: 6 max. per batch  
Number of channels per group: 20  
GX20-2: 12 max. per batch  
Number of channels per group: 20  
Channels assigned to the display group of each batch and those set as recording channels are recorded to data files.
- Batch single settings: Group, trip line, file header, data file name, text field, batch number, lot number
- Measurement mode limitations  
High speed and Dual interval measurement modes are not supported.

**OPC-UA SERVER (/E3)**

Data acquired by the GX can be accessed through Ethernet communication from a host system (OPC-UA client).

- Communication  
Mode: OPC-UA Server  
Encoding: UA Binary  
Protocol: OPC UA TCP  
Maximum number of connections: 3 sessions  
Profile Micro Embedded Device Server
- Security  
Type: None  
Encryption: None  
Login: Anonymous, Username
- Data acquisition:  
Measurement value, alarm status, and alarm value  
Computation value, alarm status, and alarm value  
Communication value, alarm status, and alarm value  
Batch information  
PV, SP, OUT, R/S, A/M/C, R/L, Alarm status in loop
- Data writing: Measurement channel (DO channel only), communication channel, alarm value, batch information, OUT, R/S, A/M/C, R/L
- Other acquired information: Device name, serial number, time, device status
- Port number: 4840 (changeable: 1 to 65535)
- Number of items:  
GX10: 100 max. (MonitoredItem/Session)  
GX20: 300 max. (MonitoredItem/Session)
- Fastest period:100ms
- Service set:

Discovery	FindServers, GetEndpoints
SecureChannel	OpenSecureChannel, CloseSecureChannel
Session	CreateSession, ActivateSession, CloseSession
View	Browse, BrowseNext, TranslateBrowsePathsToNodeIds
Attribute	Read, Write
MonitoredItem	CreateMonitoredItems, ModifyMonitoredItems, DeleteMonitoredItems, SetMonitoringMode
Subscription	CreateSubscription, ModifySubscription, DeleteSubscriptions, Publish, Republish, SetPublishingMode

---

## SLMP COMMUNICATION (Mitsubishi PLC) (/E4)

CC-Link family SLMP communication protocol function, which enables connection from a GX to Mitsubishi Electric PLCs without sequencer programs.

The GX operates as an SLMP client. Writing GX measurement data to a PLC and reading PLC data into communication channels\* are possible.

\* The communication channel function (/MC option) is required.

- Number of connection destination servers: 16 max.
- Read cycle: 100ms/200ms/500ms/1s/2s/5s/10s/20s/30s/1min
- Communicable internal data:  
Special relay (SM), special register (SD), input (X), output (Y), internal relay (M), latch relay (L), annunciator (F), edge relay (V), link relay (B), data register (D), link register (W), timer contact (TS), timer coil (TC), current timer value (TN), integration timer contact (SS), integration timer coil (SC), current integration timer value (SN), counter contact (CS), counter coil (CC), current counter value (CN), special link relay (SB), special link register (SW), direct access input (DX), direct access output (DY), index register (Z), file register (R, ZR), extended data register (D), extended link register (W)

Device code is indicated in parentheses.

## Program control function (/PG)

See GX90UT PID Control Module General Specifications (GS 04L53B01-31EN)



## ■ Limitations

### System limitations

#### Maximum number of channels

System	Measurement mode	Maximum number of module connections	Maximum number of channels			
			Input/output	Communication	Math	Report
GX10	Normal	10	100	50	50	50
	High speed	3	12	50	50	50
	Dual interval	10	50	25	25	25
GX20-1	Normal	10	100	300	100	60
	High speed	10	40	300	100	60
	Dual interval	10	50	150	50	30
GX20-2	Normal	45	500	500	200	60
	High speed	10	40	500	200	60
	Dual interval	45	250	250	100	30

#### Limit to the number of expandable I/O units or GM sub units

- Up to six units can be connected.
- Connection is not possible if the measurement mode is set to High speed.

#### Limit to the number of GX main unit modules

Module	GX10	GX20-1	GX20-2
When GX90XA-04-H0 and GX90YA are included	No limit	9	9
When GX90UT is included	No limit	8	8

#### Limit on Modules

- Up to 10 modules consisting of GX90YD, GX90WD, and GX90UT can be installed into the system.
- One GX90WD module can be installed in a GX. One module can be installed in a GX60 (expandable I/O) and each GM sub unit.
- One GX90YA module can be installed in a GX10. Two modules can be installed in each of the GX20, GX60 (expandable I/O) and GM sub unit.
- Up to 10 GX90YA modules can be installed in a GX10/GX20-1 system and up to 12 in a GX20-2 system.
- If the measurement mode is High speed, a GX90XD or GX90WD module can be installed in the system.
- If the measurement mode is High speed, only GX90XA-04-H0 (high-speed AI), GX90XD (DI), and GX90WD (DIO) are detected. DI and DIO are fixed to remote mode. Measurement and recording are not possible.
- If the measurement mode is Dual interval, GX90UT is not detected.

#### Limit to the Number of Measurement Channels

The following limitation applies to the number of channels that can measure at scan intervals shorter than 100 ms. If the measurement mode is Dual interval, the limitation applies at the scan group level. However, there are scan intervals you cannot set.

##### • Measurement mode is High speed

###### GX10

Channel	Scan interval					
	1 ms	2 ms	5 ms	10 ms	20 ms	50 ms
Input/output	1	2	5	10	12	12
math	–	1	2	5	10	25
communication	–	1	2	5	10	25
Report	–	1	2	5	10	25

**GX20-1**

Channel	Scan interval					
	1 ms	2 ms	5 ms	10 ms	20 ms	50 ms
Input.output	1	2	5	10	20	40
math	1	2	5	10	20	50
communication	3	6	15	30	60	150
Report	1	2	5	10	20	50

**GX20-2**

Channel	Scan interval					
	1 ms	2 ms	5 ms	10 ms	20 ms	50 ms
Input.output	5	10	25	40	40	40
math	2	4	10	20	40	100
communication	5	10	25	50	100	250
Report	2	4	10	20	40	60

- Measurement mode is Dual interval

**GX10**

Channel	Scan interval					
	1 ms	2 ms	5 ms	10 ms	20 ms	50 ms
Input.output	–	–	5	10	12	12
math	–	–	1	2	5	12
communication	–	–	1	2	5	12
Report	–	–	1	2	5	12

**GX20-1**

Channel	Scan interval					
	1 ms	2 ms	5 ms	10 ms	20 ms	50 ms
Input.output	–	–	5	10	20	40
math	–	–	2	5	10	25
communication	–	–	7	15	30	75
Report	–	–	2	5	10	25

**GX20-2**

Channel	Scan interval					
	1 ms	2 ms	5 ms	10 ms	20 ms	50 ms
Input.output	5	10	25	40	40	40
math	1	2	5	10	20	50
communication	2	5	12	25	50	125
Report	1	2	5	10	20	30

## Limit to the Number of Recording Channels in Each Measurement Mode

I/O channel + PID channel + math channel + communication channel

Model	Measurement mode	Recording interval										
		1ms	2 ms	5 ms	10 ms	20 ms	50 ms	100 ms	200 ms	500 ms	1 s or more	
GX10	Normal	–	–	–	–	–	–	–	100	100	100	100
	High speed	1	4	10	20	40	100	100	100	100	100	100
	Dual interval	–	–	5	10	20	50	100	100	100	100	100
GX20-1	Normal	–	–	–	–	–	–	–	100	200	500	500
	High speed	2	4	10	20	40	100	100	100	200	500	500
	Dual interval	–	–	5	10	20	50	100	100	100	250	250
GX20-2	Normal	–	–	–	–	–	–	–	500	500	1000	1000
	High speed	10	20	50	100	150	150	200	500	500	1000	1000
	Dual interval	5	10	25	40	50	50	100	20	600	600	600

### Notes on Module Installation

- When the reference junction compensation of this product is used with the thermocouple input of a GX90XA-10-U2, GX90XA-10-L1, or GX90XA-10-T1, if the following module is installed to the right (slot with the smaller number) of the GX90XA module as seen from the GX rear panel, the reference junction compensation accuracy of that module may deviate from the guaranteed range (except when GX90XA-04-H0 is installed to adjacent slots).  
GX90XA-10-C1, GX90XA-04-H0, GX90WD, GX90YA, GX90UT
- On the GX20, when the reference junction compensation of this product is used with the thermocouple input of a GX90XA-10-U2, GX90XA-10-L1, GX90XA-10-T1, or GX90XA-04-H0, if the following module is installed above, below, to the right, or to the left (slot with the smaller number) of the GX90XA module as seen from the GX rear panel, the reference junction compensation accuracy of that module may deviate from the guaranteed range.  
GX90YA, GX90UT
- If you want to use the DI of a GX90XD or GX90WD, only a single module installed in the GX main unit can be used.
- If the maximum number of I/O channels are assigned and the last channel is assigned to an intermediate channel of a connected I/O module, that module and subsequent modules will not be recognized.

#### GX10/GX20-1

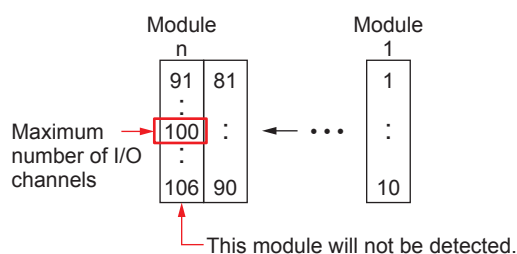

### Dual Interval File Searching of Universal Viewer

Recording mode	Link dual interval waveform <sup>*1</sup>	Show dual interval integrated link view <sup>*2</sup>
Free + Free	✓	✓
Free + Trigger (single/repeat)	–	–
Trigger (single/repeat) + Trigger (single/repeat)	–	–

\*1 Link dual interval waveform: A function that searches a folder for and displays the file that forms a pair with the displayed file.

\*2 Show dual interval integrated link view: A function that displays from the result of Search Open one of the files that forms a pair and displays both trends when it is clicked.

### PID program pattern setting from the Web application

You cannot set from the Web application. Hardware Configurator is required for setting program patterns.

## INPUT/OUTPUT MODULE SPECIFICATIONS

### ANALOG INPUT MODULE (Model GX90XA or Option /Uxx0)

### DIGITAL INPUT MODULE (Model GX90XD or Options /CRx1)

### DIGITAL OUTPUT MODULE (Model GX90YD, or Options /CR1x, /CR2x, /CR4x)

### DIGITAL INPUT/OUTPUT MODULE (Model GX90WD)

### PULSE INPUT MODULE (Model GX90XP)

### ANALOG OUTPUT MODULE (Model GX90YA)

### PID CONTROL MODULE (Model GX90UT)

Please see GX90XA/GX90YA/GX90XD/GX90YD/GX90WD/GX90XP Input/Output Module (GS 04L53B01-01EN) and PID Control (GS 04L53B01-31EN) General Specification.

## APPLICATION SOFTWARE

### SMARTDAC+ STANDARD

- Universal viewer
- Hardware configurator (with Program pattern setting)

Download the latest version of the software from the following URL;

[www.smartdacplus.com/software/en/](http://www.smartdacplus.com/software/en/)

### Operating environment

#### OS:

OS	Type
Windows 7	Home Premium SP1 (32-bit and 64-bit Editions)
	Professional SP1 (32-bit and 64-bit Editions)
Windows 8.1	Update
	Pro Update
Windows 10	Home (32-bit and 64-bit Editions)
	Pro (32-bit and 64-bit Editions)

### Processor and main memory:

OS	Processor and main memory
Windows 7 Windows 8.1 Windows 10	32-bit edition Intel Pentium 4, 3GHz or faster x64 or x86, 2GB or more 64-bit edition Intel x64 processor that is equivalent to Intel Pentium 4, 3 GHz or faster, 2GB or more

### Browser:

Supported browser: Internet Explorer 11  
HTTP1.1 and JavaScript are used.

### Hard disk:

- 100MB or more of free space

### Display:

- A video card that is recommended for the OS and a display that is supported by the OS, has a resolution of 1024 x 768 or higher, and that can show 65,536 colors (16-bit, high color) or more.

### Universal Viewer software

The universal viewer can display the following data generated by the recorder on the screen and print it out on the printer.

- Display data file
- Event data file
- Report data file (Including Hour, Day, Week Month)
- Manual sample data file

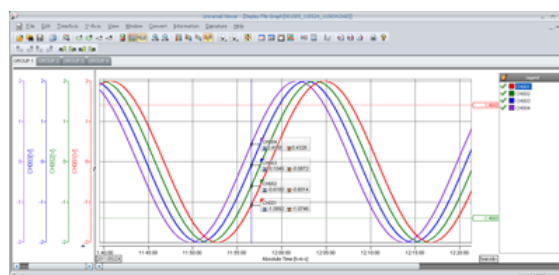

- Viewer function  
Waveform display, digital display, circular display, list display, report display, operation log display etc.
- Data conversion:  
File conversion to ASCII or MS-Excel format
- Signin function

### Web application/Hardware configurator

- Online setting on Web browser (IE)
- Offline setting on Web browser (IE)

Both settings can be made using browsers such as Internet Explorer 11.

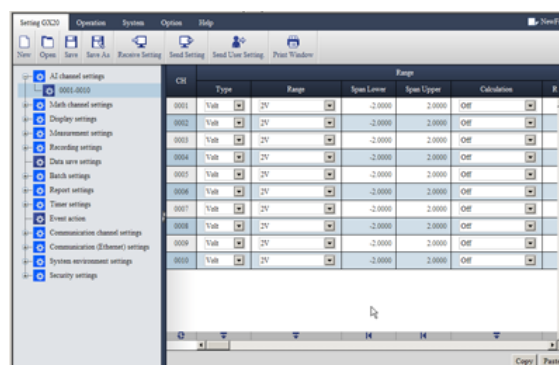

## MODEL AND SUFFIX CODES

Model	Suffix Code	Optional code	Description
GX10			Paperless recorder (Panel mount type, Small display) <sup>*13</sup>
GX20			Paperless recorder (Panel mount type, Large display) <sup>*13</sup>
Type	-1		Standard (Max. measurement channels: 100 ch)
	-2		Large memory (Max. measurement channels: 500 ch) <sup>*12</sup>
Display language	E		English, degF, DST (summer/winter time) <sup>*10</sup>
Optional features	/AH		Aerospace heat treatment
	/AS		Advanced security function (Part 11) <sup>*21</sup>
	/BC		Black cover
	/BT		Multi-batch function <sup>*22</sup>
	/C2		RS-232 <sup>*1</sup>
	/C3		RS-422/485 <sup>*1</sup>
	/CG		Custom display <sup>*15</sup>
	/D5		VGA output <sup>*2</sup>
	/E1		EtherNet/IP communication (PLC communication protocol) <sup>*18</sup>
	/E2		WT communication <sup>*14</sup>
	/E3		OPC-UA server
	/E4		SLMP communication (Mitsubishi PLC) <sup>*19</sup>
	/FL		Fail output, 1 point
	/LG		Log scale
	/MT		Mathematical function (with report function) <sup>*16 *17</sup>
	/MC		Communication channel function <sup>*20</sup>
/P1		24 V DC/AC power supply	
/PG		Program control function <sup>*23</sup>	
/UH		USB interface (Host 2 ports)	

### Analog input module, Digital I/O module:

Please add the following suffix codes to the main unit model and specification codes.

Option	Optional code	Description
Optional features (Analog input) <sup>*3*11</sup>	/UC10	With analog input module, 10ch (Clamp terminal)
	/UC20	With analog input module, 20ch (Clamp terminal) <sup>*7</sup>
	/UC30	With analog input module, 30ch (Clamp terminal) <sup>*8</sup>
	/UC40	With analog input module, 40ch (Clamp terminal) <sup>*5</sup>
	/UC50	With analog input module, 50ch (Clamp terminal) <sup>*5</sup>
	/US10	With analog input module, 10ch (M3 screw terminal)
	/US20	With analog input module, 20ch (M3 screw terminal) <sup>*7</sup>
	/US30	With analog input module, 30ch (M3 screw terminal) <sup>*8</sup>
	/US40	With analog input module, 40ch (M3 screw terminal) <sup>*5</sup>
	/US50	With analog input module, 50ch (M3 screw terminal) <sup>*5</sup>
Optional features (Digital I/O) <sup>*4</sup>	/CR01	With digital I/O module, (Output:0, Input:16) <sup>*8 *9 *16</sup>
	/CR10	With digital I/O module, (Output:6, Input:0) <sup>*8</sup>
	/CR11	With digital I/O module, (Output:6, Input:16) <sup>*7 *8 *9 *16</sup>
	/CR20	With digital I/O module, (Output:12, Input:0) <sup>*6</sup>
	/CR21	With digital I/O module, (Output:12, Input:16) <sup>*6 *9 *16</sup>
	/CR40	With digital I/O module, (Output:24, Input:0) <sup>*6</sup>
	/CR41	With digital I/O module, (Output:24, Input:16) <sup>*6 *9 *16</sup>

\*1 /C2 and /C3 cannot be specified together.

\*2 /D5 can be specified only for the GX20.

\*3 Only one option can be specified.

- \*4 Only one option can be specified.
- \*5 /UC40, /UC50, /US40 and /US50 cannot be specified for the GX10.
- \*6 /CR20, /CR21, /CR40 and /CR41 cannot be specified for the GX10.
- \*7 If /UC20 or /US20 is specified, /CR11 cannot be specified for the GX10.
- \*8 If /UC30 or /US30 is specified, /CR01, /CR10 and /CR11 cannot be specified for the GX10.
- \*9 Digital input module have M3 screw terminals.
- \*10 The Display language is selectable from English, German, French, Russian, Korean, Chinese, Japanese. (As of Mar., 2013)  
To confirm the current available languages, please visit the following website.  
URL: <http://www.yokogawa.com/ns/language/>
- \*11 Universal type (Type Suffix Code: -U2). If you need the electromagnetic relay type (Type Suffix Code: -T1), current (mA) input (Type Suffix Code: -C1) type, L-model DCV/TC/DI, scanner type (Type Suffix Code: -L1), High-speed universal type (Type Suffix Code: -H0), 4-wire RTD/resistance type (Type Suffix Code: -R1), purchase it separately.
- \*12 Large memory type can be specified only for the GX20.
- \*13 To connect an expandable I/O, GM sub unit, you will need one expansion module for the GX.
- \*14 /MC option must be separately specified when the WT communication is selected.
- \*15 Creating custom displays requires DXA170 DAQStudio (sold separately). (GX does not have a creation function.)
- \*16 Optional code /MT (MATH) required if using the GX90XD's or GX90WD's pulse input.
- \*17 The /MT option (computation) is required to perform pulse integration on GX90XP pulse input modules.
- \*18 If you want to write from a PLC to the GX via EtherNet/IP communication, a separate communication channel (/MC) is required.
- \*19 If you want the GX to load data from SLMP servers via SLMP communication, a separate communication channel (/MC) is required.
- \*20 If you want to load data from other devices into the GX using Modbus client, a communication channel (/MC) is required.
- \*21 When the advanced security function is set to ON, the scan interval is set to 100 ms or longer. In addition, the dual interval function and PID modules cannot be used.
- \*22 When the multi-batch function is set to ON, the scan interval is set to 500 ms or longer. In addition, the dual interval function cannot be used.
- \*23 A PID control module is required to use the program control function.

#### Analog input/output module, Digital I/O module (sold separately):

**MODEL and SUFFIX Code (GX90XA)**

**MODEL and SUFFIX Code (GX90XD)**

**MODEL and SUFFIX Code (GX90YD)**

**MODEL and SUFFIX Code (GX90WD)**

**MODEL and SUFFIX Code (GX90XP)**

**MODEL and SUFFIX Code (GX90YA)**

**MODEL and SUFFIX Code (GX90UT)**

Please see GX90XA/GX90YA/GX90XD/GX90YD/GX90WD/GX90XP Input/Output Module (GS 04L53B01-01EN) and PID Control Module (GS 04L53B01-31EN) General Specification.

#### When connecting the Expandable I/O

Please see GX60 Expandable I/O, GX90EX Expansion Module General Specification (GS 04L53B00-01EN.)

### ■ Standard Accessories

Product	Qty
Mounting bracket (for GX10 or GX20)	2
SD memory card (1GB)	1
Stylus pen (touch pen)	1
Tag sheet (for GX10 or GX20)	1
Sheet (paper) (for GX10 or GX20)	1
Dummy cover (For empty slots)	-

### ■ Application Software (Sold Separately)

Model	Description	OS
DXA170	DAQStudio	Windows 7/8/8.1/10
GA10	Data Logging Software	Windows 7/8.1/10 Windows Server 2008/2012/2016

### ■ Optional Accessories (Sold Separately)

Product	Model/part no.
Model SD memory card (1GB)	773001
Mounting bracket	B8740DY
Stylus pen (touch pen)	B8740BZ
Shunt resistor for M3 terminal (250 Ω ± 0.1 %)	415940
Shunt resistor for M3 terminal (100 Ω ± 0.1 %)	415941
Shunt resistor for M3 terminal (10 Ω ± 0.1 %)	415942
Shunt resistor for Clamp terminal (250 Ω ± 0.1 %)	438920
Shunt resistor for Clamp terminal (100 Ω ± 0.1 %)	438921
Shunt resistor for Clamp terminal (10 Ω ± 0.1 %)	438922
Dummy cover	B8740CZ
Validation Documents (For /AS option) *1	773230

- \*1 Provision of Validation Documents  
A license sheet containing the license key required for installation is provided.  
Download the validation document from the following URL.  
<http://www.smartdacplus.com/software/en/>

**Calibration certificate (sold separately)**

When ordering the GX10/GX20 with options (analog input), the calibration certificate for the modules is included in and shipped with the calibration certificate of the main unit. When ordering an analog input module separately, each module gets its own calibration certificate (one certificate per module).

**Test certificate (QIC, sold separately)**

When ordering the GX10/GX20 with options (analog/digital I/O), the QIC for each module is included in and shipped with the QIC of the main unit. When ordering analog input modules and digital I/O modules separately, each module gets its own QIC (one QIC per module).

**User's Manual**

Product user's manuals can be downloaded or viewed at the following URL. To view the user's manual, you need to use Adobe Reader 7 or later by Adobe Systems.

**URL:** [www.smartdacplus.com/manual/en/](http://www.smartdacplus.com/manual/en/)

**Product Purchase Specifications**

The GX10/GX20 is composed of the main unit, I/O modules, Expandable I/O, and Expansion module.

There are two ways to purchase I/O modules.

One way is to purchase them individually by specifying models GX90XA, GX90XD, GX90YD, GX90WD, and GX90XP, GX90YA, GX90UT.

The other way is to purchase them as an option (/UCxx or /USxx). Purchasing them as an option is convenient, but this places limitations on the number of analog inputs that you can obtain.

If you want to use more than 50 channels, please purchase the I/O modules individually.

To connect expandable I/O (GX60), GM sub unit to GX10 or GX20, you must purchase one unit of expansion module (GX90EX) for GX10/GX20 in addition to the expandable I/O, GM sub unit.

**Trademarks**

The TCP/IP software used in this product and the document for that TCP/IP software are based in part on BSD networking software, Release 1 licensed from The Regents of the University of California.

- SMARTDAC+ and SMARTDACPLUS are trademarks of Yokogawa Electric Corporation.
- Microsoft, MS and Windows are registered trademarks of Microsoft Corporation USA.
- Pentium are registered trademarks of Intel Corporation.
- Modbus is a registered trademark of AEG Schneider.
- Kerberos is a trademark of MIT.
- Java and Java-related trademarks are trademarks or registered trademarks of Sun Microsystems, Inc. in the United States and/or other countries.
- Other company and/or product names are registered trade mark of their manufactures.