



# SMARTDAC+

Data Acquisition & Control

Paperless recorder GX/GP

# SMARTDAC+<sup>®</sup>

## Data Acquisition & Control

Your business environment is complex and fast changing.

You need smart and powerful systems that can adapt to your process.

**SMARTDACPLUS<sup>®</sup>** is a fresh approach to data acquisition and control, with smart and simple touch operation as a design priority.

Measure, display and record process data with greater levels of clarity, intelligence and accessibility.

The **SMARTDACPLUS<sup>®</sup>** concept begins with the all-new GX/GP, an integrated I/O and recording system with a familiar touch operator interface.

Highly adaptable, very capable and easy to operate is the new GX/GP.

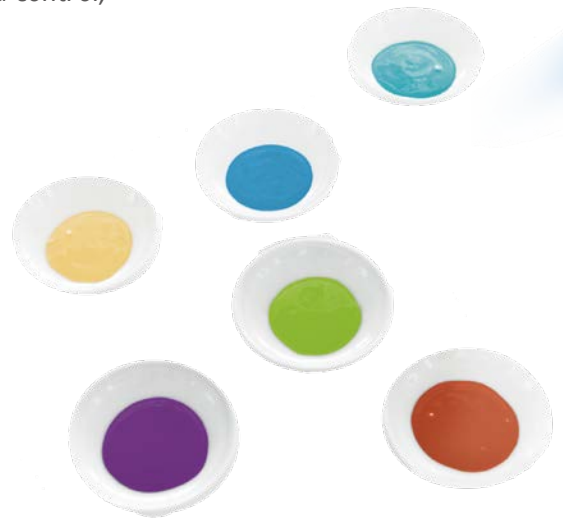

**Now that's SMART.**

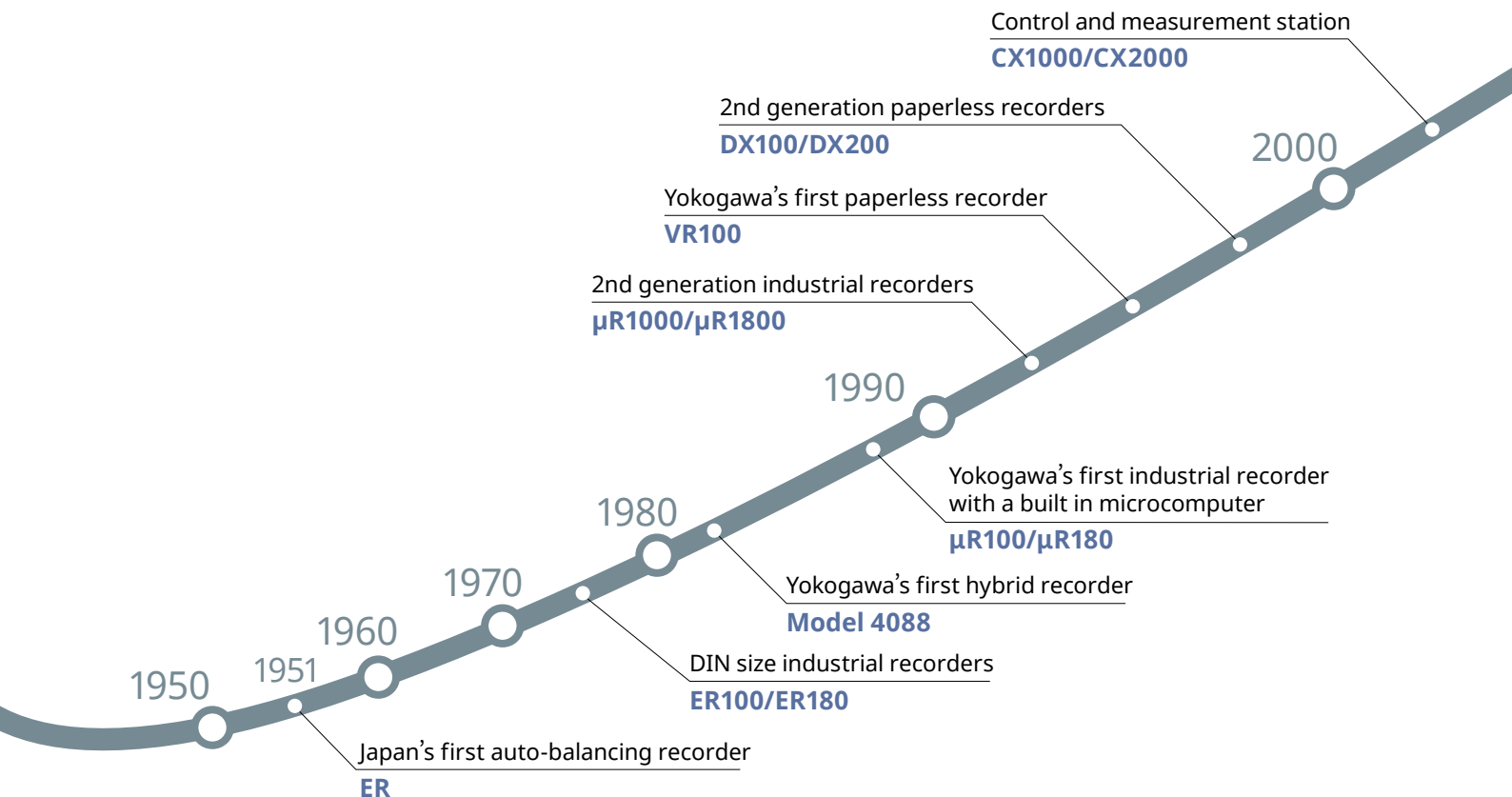



4th generation paperless recorders  
**GX10/GX20, GP10/GP20**

2017

2012

2010

3rd generation paperless recorders  
**DXAdvanced DX1000/DX2000**

3rd generation industrial recorders  
**μR10000/μR20000**





# SMARTDAC+<sup>®</sup>

## Data Acquisition & Control

### What's New

- PID control (GX90UT PID Control Module)
- Program control (/PG option)
- Dual interval measurement
- High speed (1 ms) measurement (GX90XA-04-H0 High Speed AI Module)
- 4-wire RTD input, resistance measurement (GX90XA-06-R1 4-Wire RTD Module)
- Retransmission/manual mA output (GX90YA Analog Output Module)

### Display & operation

- Arrange screens any way you like with the Custom Display function (option)
- Wide variety of powerful display functions
- Touch screen for greater ease of use
- Remote monitoring and setting control from a web browser



### Data use

- Automatically print reports
- Powerful software for a variety of tasks including data analysis, settings, and acquisition
- Save to binary or text format
- SLMP Communication (Mitsubishi PLC)



### Recording

- Supports long term multi-channel recording
- Redundancy through internal memory and external media
- Saves binary data for enhanced security (also supports plain text)



### Measurement

- Inputs and outputs that support a wide range of DUTs (device under test)
- Modular construction for expandable input/output
- Multichannel measurement on up to 450 channels
- Pulse signal data acquisition with integration

# Reliable technology

## Proven reliability over a wide range of applications



Navigate with ease

### Smart User Interface

- Observe**
  - Wide variety of display formats
  - Powerful data search functions
  - Alarm/Status indicator functions
- Interact**
  - Touch screen for intuitive operation
  - Easy-to-navigate, user-oriented design
  - Supports freehand messages



Ready for the future when you are

### Smart Architecture

- Adapt**
  - Add I/O modules as needed
  - Wide ambient temperature operation
  - Locking front panel for media security
- Measure**
  - Wide range of I/O modules
  - Multichannel I/O
  - Easy-to-read screens



Data analysis made simple and mobile

### Smart Functionality

- Record**
  - Direct report output to printers
  - User defined report creation tool
  - Viewer software for data analysis
- Connect**
  - Browser-based real time monitoring
  - Centralized data management via FTP server
  - Powerful networking functions

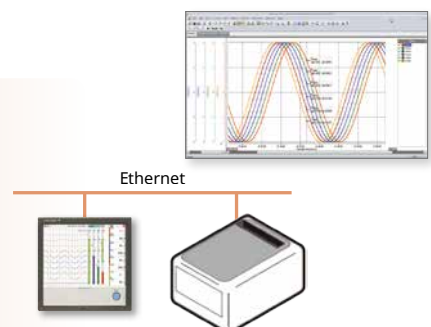



# An intuitive UI engineered for ease-of-use

## Smart User Interface

### Efficiently search for key data

#### Easily review historical data

Seamless display of historical trends—flick or drag the trend display to scroll through the data, even during measurement.

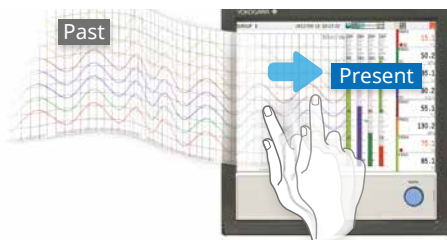

Flick

#### Quickly find data using calendars and summary screens

From a calendar, jump to waveforms of a specific date. From the alarm summary, jump to the waveform active during the alarm.

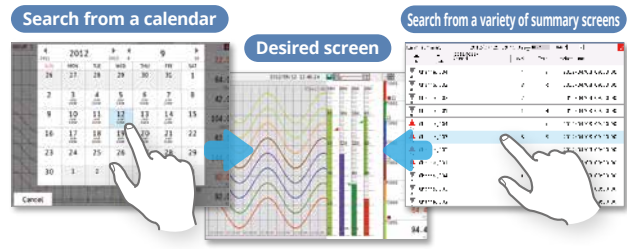

Historical trend screen

### Easily check off trouble spots

#### Write freehand messages

Immediately clear areas of concern with a hand-written message.



You can draw or hand-write on the waveform area using a stylus (standard accessory) or the tip of your finger. You can even select a color and line width. Alternatively, you can select from a list of preset messages.

#### Save and output image files

Save trend waveforms of interest or screens displayed during alarms as image (PNG) files, and print them out at the same time.

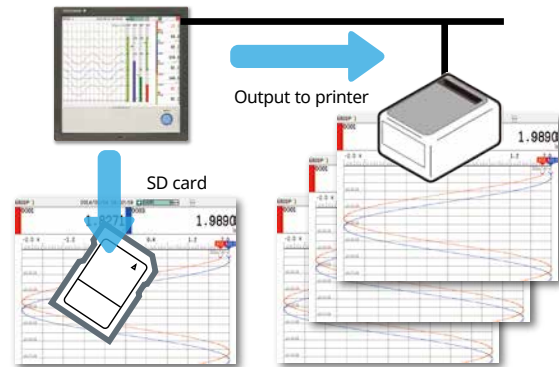

PNG file (snapshot)

Example output

### Check waveforms of concern in detail

#### Display digital values at any location

Move the scale to display the value corresponding to that position as a numeric value. Instantly check maximum/minimum measured values.

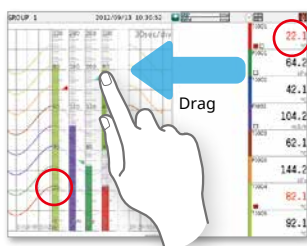

[Patent technology]

#### Ascertain long-duration trends at a glance

##### All historical trends display

Long-duration trends can be fitted to a single screen for easy viewing.

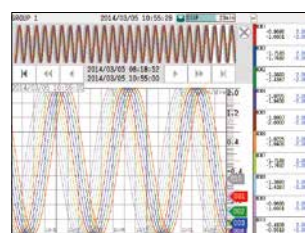

All historical trends display

#### Zoom in/out - time axis and engineering units

The time axis and engineering axis can be expanded and compressed using a simple pinch together or apart function.

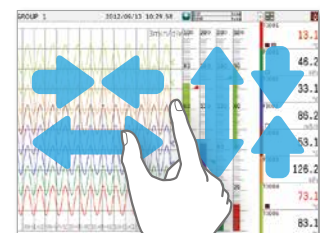

Pinch apart / Pinch together



## Create your own screens

### Custom display (/CG option)

You can arrange display objects such as trend, numeric, and bar graphs any way you like to create monitor displays that are customized to the environment.

Start/stop pumps and perform other operations.

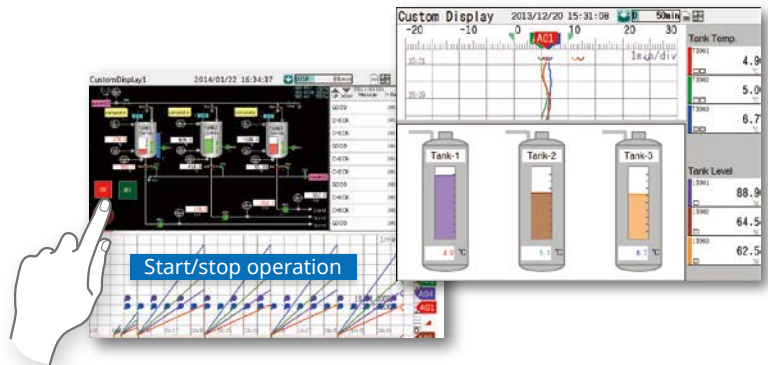

### Custom display building software

#### DAQStudio DXA170

DAQStudio is software for creating custom displays. You can load screens you created onto the GX/GP via Ethernet or external memory media (SD/USB) and display them.

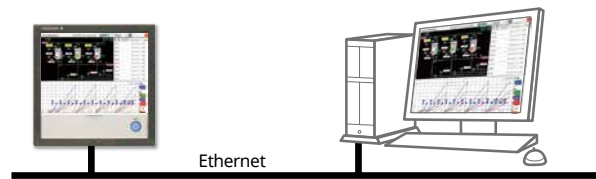

### Common objects used in custom displays (DAQStudio)



Image (displays PNG files)

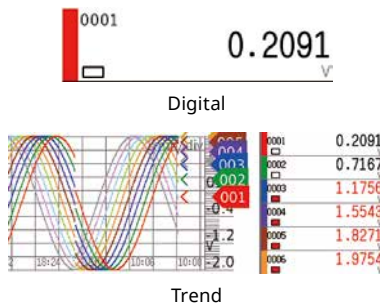

Digital

Trend

Label

Label

UP	DOWN	Channel	Level	Type	Alarm time
▲		0003	1	H	2014/03/13 10:12:52.000
▲		0004	1	H	2014/03/13 10:12:37.000
▲		0005	1	H	2014/03/13 10:12:22.000
▲		0006	1	H	2014/03/13 10:12:07.000
▲		0007	1	H	2014/03/13 10:11:52.000
▲		0008	1	H	2014/03/13 10:11:37.000
▲		0009	1	H	2014/03/13 10:11:22.000
▲		0010	1	H	2014/03/13 10:11:07.000
▼		0001	1	H	2014/03/13 10:09:23.000
▼		0002	1	H	2014/03/13 10:09:08.000

Alarm summary

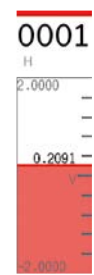

Bar graph

## Variety of display screens

Trend

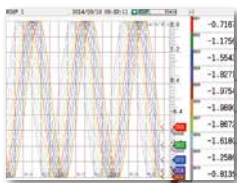

Bar graph



Digital

Overview

Alarm summary

Channel	Level	Type	Alarm time
Channel 001	1	H	2014/03/13 10:12:52.000
Channel 002	1	H	2014/03/13 10:12:37.000
Channel 003	1	H	2014/03/13 10:12:22.000
Channel 004	1	H	2014/03/13 10:12:07.000
Channel 005	1	H	2014/03/13 10:11:52.000
Channel 006	1	H	2014/03/13 10:11:37.000
Channel 007	1	H	2014/03/13 10:11:22.000
Channel 008	1	H	2014/03/13 10:11:07.000
Channel 009	1	H	2014/03/13 10:09:23.000
Channel 010	1	H	2014/03/13 10:09:08.000

Message summary

Memory summary

Message No.	Date	Factor	File name
2013/04	2013/04/08 09:19:41		File001
2013/04	2013/04/08 09:19:41		File002
2013/04	2013/04/08 09:19:41		File003
2013/04	2013/04/08 09:19:41		File004
2013/04	2013/04/08 09:19:41		File005
2013/04	2013/04/08 09:19:41		File006
2013/04	2013/04/08 09:19:41		File007
2013/04	2013/04/08 09:19:41		File008
2013/04	2013/04/08 09:19:41		File009
2013/04	2013/04/08 09:19:41		File010

### Physical quantities are displayed and recorded on a log scale.

Log scale display (/LG option)

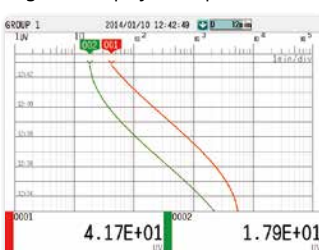

Log scale

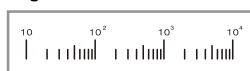

Displays exponents

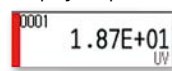

### Multi-panel display

You can select from 9 layouts, and save up to 20 configurations. (Multi panel available on the GX20/GP20 only)

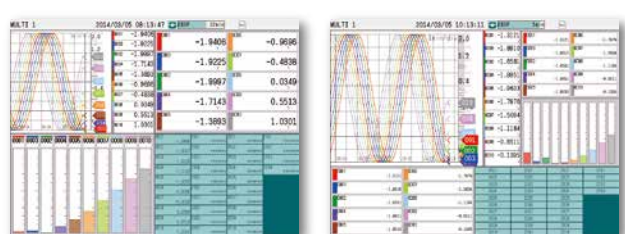

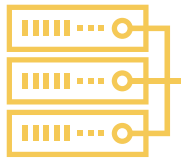

# Highly flexible and scalable architecture

## Smart Architecture

### Modular input/output

Inputs and outputs are modular for easy expandability. The GX/GP multichannel paperless recorder main unit alone provides up to 100 channels (GX20/GP20) of measurement.



Select from a wide variety of input /output modules.



The I/O terminals are detachable.

Model	Name	Measurement/Application	Channels
GX90XA-10-U2	Analog input module	DC voltage, DC current (with external shunt resistor connected), thermocouple, RTD, contact (solid state relay scanner type)	10
GX90XA-10-L1		DC voltage, DC current (with external shunt resistor connected), thermocouple, contact (Low withstand voltage solid state relay scanner type)	10
GX90XA-10-T1		DC voltage, DC current (with external shunt resistor connected), thermocouple, contact (electromagnetic relay scanner type)	10
GX90XA-10-C1		DC current (mA) (solid state relay scanner type)	10
GX90XA-04-H0		DC voltage, DC current (with external shunt resistor connected), thermocouple, RTD, contact (individual A/D type)	4
GX90XA-06-R1		4-wire RTD, 4-wire resistance (solid state relay scanner type)	6
GX90YA	Analog output module	Current output	4
GX90XD	Digital input module	Remote control input or operation recording	16
GX90YD	Digital output module	Alarm output	6
GX90WD	Digital input/output module	Remote control input or operation recording/alarm output	DI:8/DO:6
GX90XP	Pulse input Module	Pulse signal data acquisition, integral count	10
GX90UT	PID control module	PID control (2 loop)	AI:2/AO:2 DI:8/DO:8

### Expandable to up to 450 channels (real actual input)

Supports up to 450 channels of measurement. Note that if MATH and communication channels are included, the GX20/GP20 large memory type can record on up to 1000 channels. The GX/GP main unit and expandable I/O can both use the same input/output modules.

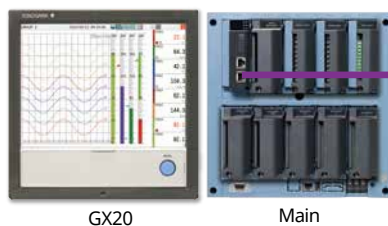

LAN cable (CAT5 or later)

Chain up to 6 units

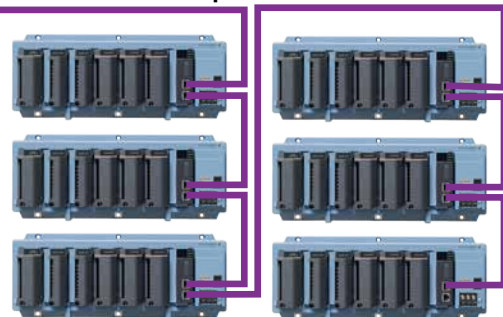

The maximum distance between units is 100 m

### Reduce wiring with distributed installation

When the recorder is installed offsite (away from the DUT), you can place the expandable I/O at the site and monitor data without the need for long-distance wiring of thermocouples and other sensors.

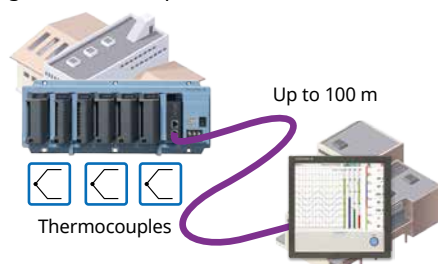

You connect directly with a LAN cable without connecting through a hub or repeater.

\* You can also connect subunits of the GM Data Acquisition System.

Model	Type	Max. channels	Number of channels by configuration	
GX10/GP10	Standard	100ch	Main unit only	0-30
			Main + expandable I/O	0-100
GX20/GP20	Standard	100ch	Main unit only	0-100
			Main + expandable I/O	0-100
	Large memory	450ch	Main unit only	0-100
			Main + expandable I/O	0-450

The number of channels is for analog input only.



## Component Names

### GX20



#### LCD screen

Displays operating screens such as trend graphs, and setting screens.

#### Operation panel

#### MENU key

Simply press the MENU key to display a menu for access to a variety of screens.

#### Front panel door lock mechanism

### GP20



#### Handle

The START/STOP key can be used when the operation panel is closed.

#### Feet

### With front panel door open

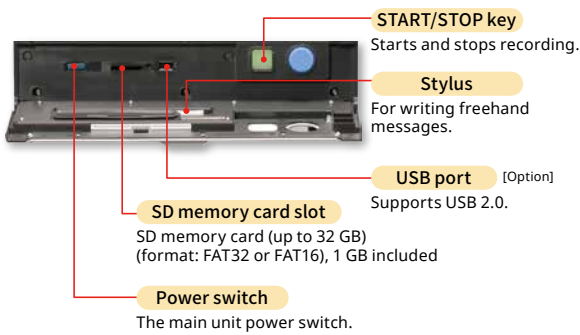

#### START/STOP key

Starts and stops recording.

#### Stylus

For writing freehand messages.

#### USB port [Option]

Supports USB 2.0.

#### SD memory card slot

SD memory card (up to 32 GB) (format: FAT32 or FAT16), 1 GB included

#### Power switch

The main unit power switch.

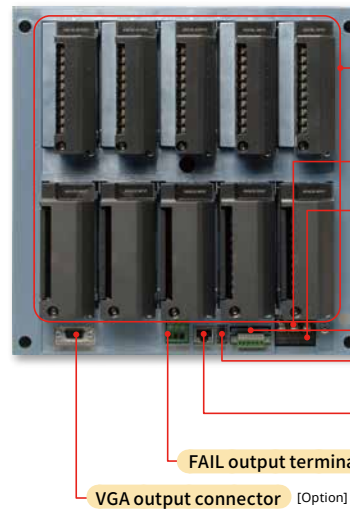

#### Input/output module slots

#### Power inlet (GP10/GP20)

#### Power and protective ground

#### Serial communications port [Option]

Terminal for RS-422/485 or RS-232 communications.

#### USB port [Option]

Supports USB 2.0.

#### Ethernet Port [Option]

A 10Base-T/100Base-TX port.

#### FAIL output terminal [Option]

#### VGA output connector [Option]

External monitor connector.

## Connect a mouse and keyboard for a "PC feel"

USB interface (/UH option)

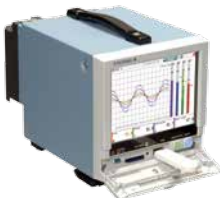

- Keyboard
- Memory
- Mouse
- Bar code reader



## Runs on DC12 V power for in-vehicle data acquisition.

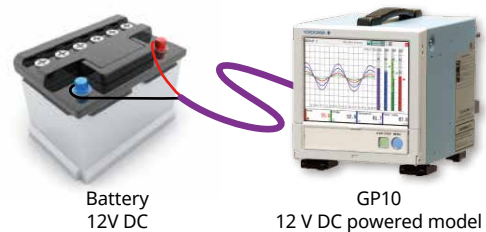

Battery  
12V DC

GP10  
12 V DC powered model

## Choose by mounting design and application



Cover color  
(/BC option)(GX)



Portable models  
(GP10/GP20)

## Easy-to-read display

- GX20/GP20:12.1" TFT color LCD, 800 x 600 dots
- GX10/GP10:5.7" TFT color LCD, 640 x 480 dots

GX10

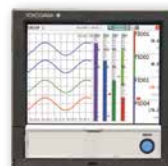

GP10

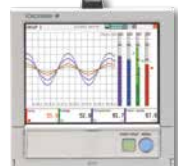



# A full range of network functions and software Smart Functionality

## Real time remote monitoring from a web browser

Through a Web browser you can monitor the GX/GP in real time and change settings. You can easily build a seamless, low-cost remote monitoring system with no additional software.

### Real time monitoring screen

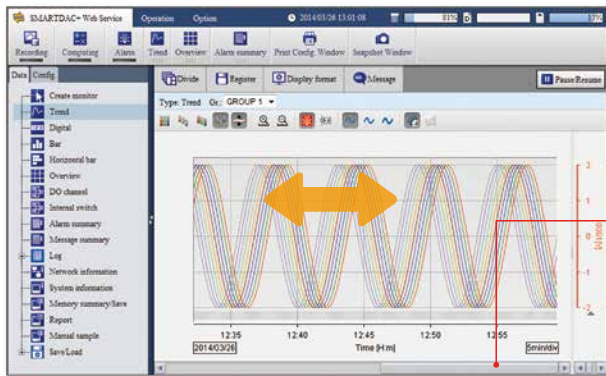

You can view monitor screens in real time that are identical to the trends, digital, and other displays on the GX/GP main unit.

With the scroll bar, you can seamlessly scroll between past and current trends. When the sampling interval is 1 second, the instrument displays 1 hour's worth of historical trends.

### Enter settings online with a web browser

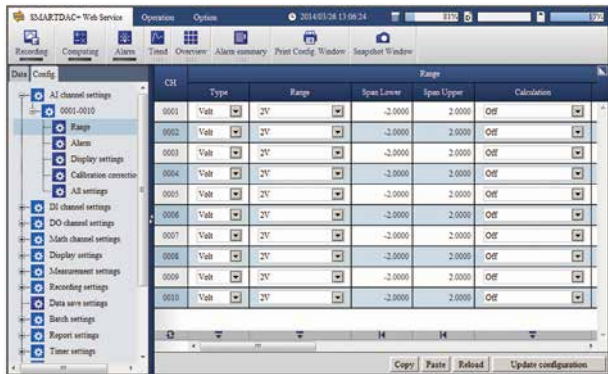

The setting screen lets you copy AI channel settings and other information to Excel for editing. You can reimport the data into the setting screen after editing.

	A	B	C	D	E	F	G	H	I	J	K	L
1		1	RTD	Ph100	0	150	Off	1	2	0	100	off
2		2	RTD	Ph100	0	150	Off	1	2	0	100	off
3		3	RTD	Ph100	0	150	Off	1	2	0	100	off
4		4	RTD	Ph100	0	150	Off	1	2	0	100	off
5		5	RTD	Ph100	0	150	Off	1	2	0	100	off
6		6	RTD	Ph100	0	150	Off	1	2	0	100	off
7		7	RTD	Ph100	0	150	Off	1	2	0	100	off
8		8	RTD	Ph100	0	150	Off	1	2	0	100	off
9		9	RTD	Ph100	0	150	Off	1	2	0	100	off
10		10	RTD	Ph100	0	150	Off	1	2	0	100	off
11												

## Dedicated software (free download) is available for loading waveforms and GX/GP settings

### Universal viewer

Data files saved on the GX/GP can be viewed and printed. You can perform statistical computation over an area and export to ASCII, Excel, or other formats.

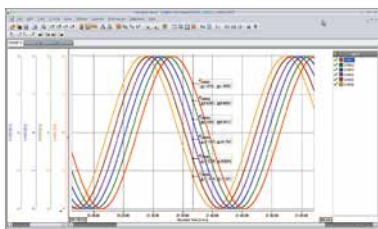

Data converted to an ASCII file

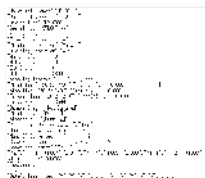

### Offline setting software

Save settings or transfer them to the GX/GP.

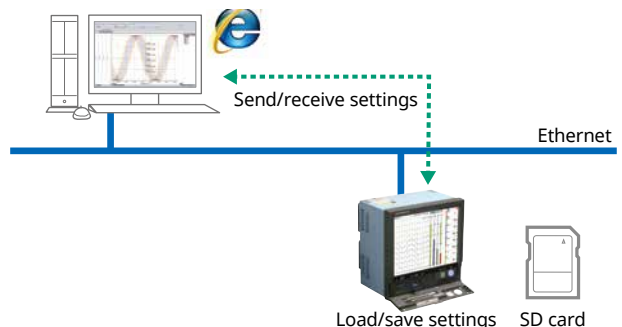

## Web screen

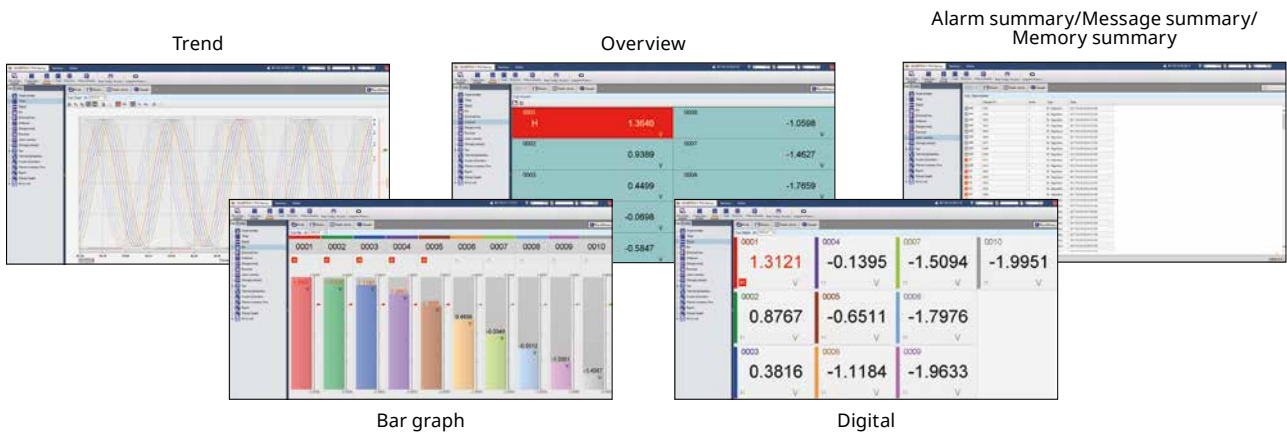

## Mobile Web

Enables monitoring from a tablet

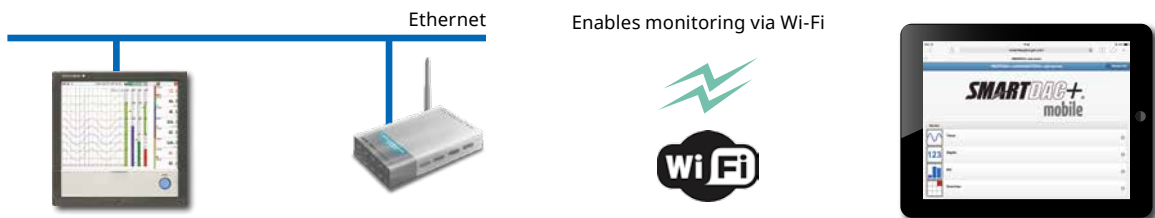

## Aerospace Heat Treatment Supports heat treatment application AMS2750/NADCAP

### Calibration correction schedule control function (/AH option)

Schedule management for periodically executing calibration correction configuration and the like. The correction factor can be set separately for unit and sensor dependency. TUS report software enables you to easily create TUS (temperature uniformity survey) reports.

\* For information on TUS software, contact your Yokogawa representative.

Reminder	
Furnace 1 Calibration	Furnace 4 Calibration
Time until due date: 63 days	Time until due date: 7 days
Furnace 2 Calibration	Furnace 5 Calibration
Time until due date: 70 days	Time until due date: 28 days
Furnace 3 Calibration	Furnace 6 Calibration
Time until due date: 0 days	Time until due date: 35 days

Calibration Reminder Screen

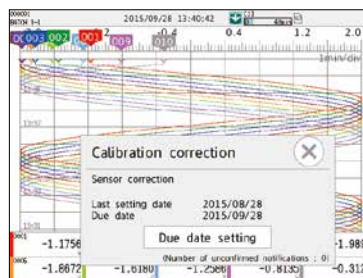

Message to prompt calibration

A screenshot of the 'Due date setting' configuration screen. It includes fields for 'Schedule number' (set to 1), 'Reminder function' (set to On/Off), 'Due date' (set to 2015/10/28), and 'Due date setting'. There are 'Exit' and 'Save' buttons at the bottom.

Calibration schedule setting

## Record data in separate files per equipment set

### Multi-batch Function (/BT option)

Recorder pre-defined channel groups to separate data files with independent start and stop control. Up to 12 independent batches can be created.

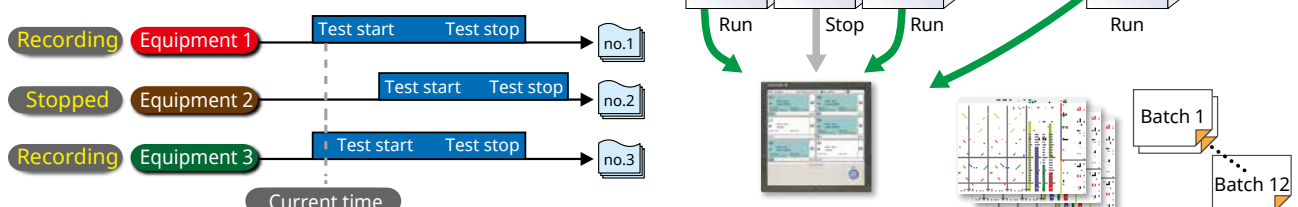



## PID control function

### Control function

Enables PID and program control

- PID control module  
2-loops per module, up to 20 loops per system
- Setpoint program control function (/PG option)  
Up to 99 patterns

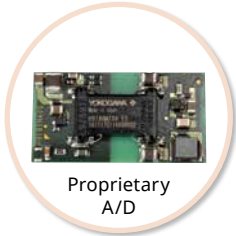

Proprietary A/D



GX90UT  
PID control module

New

### Remote operation and monitoring

The web application enables remote operation and monitoring from a browser.

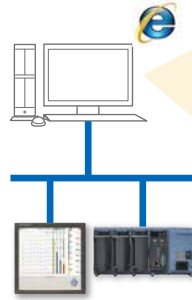

With the Web Server function, simply access the GX/GP from a web browser on a PC for easy operation and monitoring of control loops.

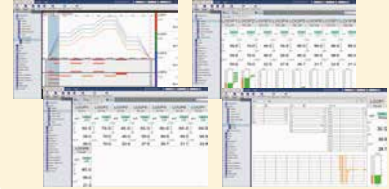

### Built in control screens and display

Various pre-configured control screens and display are available.

Run programs (/PG)

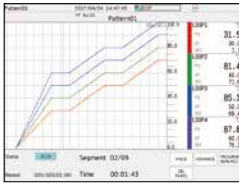

Tuning

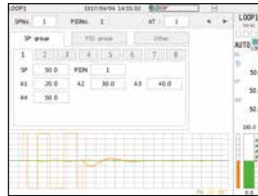

Control overview

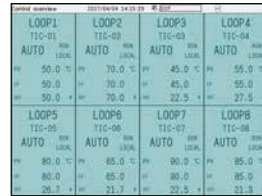

Control alarm summary

Loop No.	Alarm Type	Time	Status
LOOP4	2	2015/10/30 12:58:20.720	OK
LOOP4	2	2015/10/30 12:45:47.100	OK
LOOP4	1	2015/10/30 12:44:45.100	OK
LOOP4	1	2015/10/30 12:44:16.100	OK
LOOP4	2	2015/10/30 12:38:30.100	OK
LOOP4	1	2015/10/30 12:38:30.100	OK
LOOP4	1	2015/10/30 12:38:30.100	OK
LOOP4	2	2015/10/30 12:38:30.100	OK

Control groups



Controller

Face plate

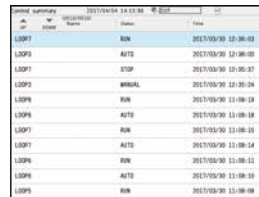

Control operation summary

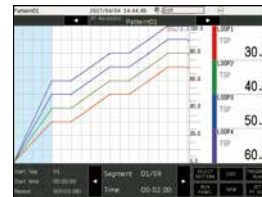

Select programs

### Seamless integration

Combine and integrate complex legacy control panel into a simple and flexible data acquisition station.

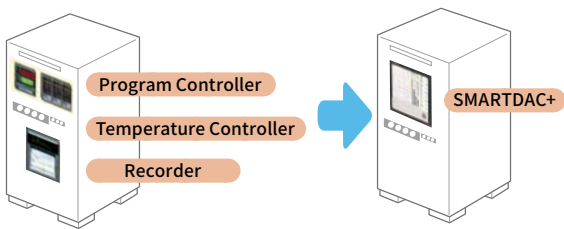

### Custom display

Remote operation is possible through screens that are customized for your specific system.

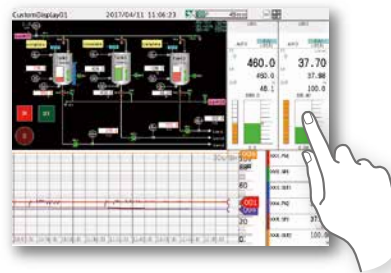

### Application examples

#### Industrial furnace

- Ideal for **centralized control** of multiple loops
- Modular structure makes for **easy maintenance** of individual loops

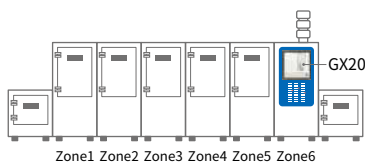

#### Utility equipment

- Simplifies loop control and **remote monitoring** of utility equipment
- Readily scalable for **additional loops**

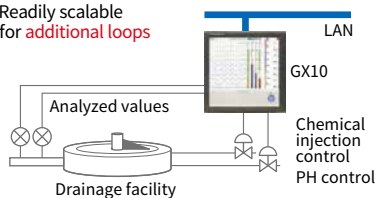

#### Engine endurance test bench

- Measures evaluation data while **generating test patterns**

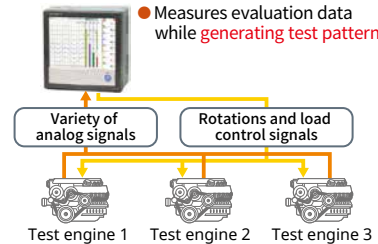

## High speed measurement (down to 1 ms)

Yokogawa's proprietary A/D converter allows the high speed module to measure data points as fast 1ms.

- High speed (1 ms) measurement\*
- Proprietary A/D converter

\* With 1ch per module.  
At 2 ms, 2 ch per module, and at 5 ms or more, all 4 ch per module.

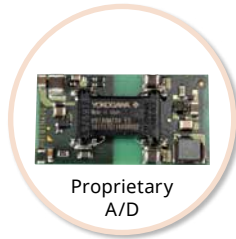

### Max. channels

Model	Scan interval		
	1ms	5ms	10ms
GX/GP10	1ch	5ch	10ch
GX20-1/GP20-1	1ch	5ch	10ch
GX20-2/GP20-2	5ch	25ch	40ch

## Dual interval measurement with two different scan intervals

Users have the ability to choose two different scan intervals on a single GX/GP system. This allows users the flexibility to measure various types of inputs with two different scan intervals in a single system. For example, this provides for efficient, simultaneous measurement of signals with slow fluctuations such as temperature, and fast-changing signals such as pressure and vibration. Modules can be assigned to measurement groups.

2 measurement groups

Easily switch groups

Superimpose data on Universal Viewer

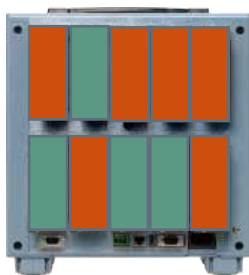

- Measurement group 1
- Measurement group 2

The figure above shows 2 measurement groups by color.

Channels for measurement group 1



Simply swipe to switch measurement groups.

Channels for measurement group 2



Measurement group 1

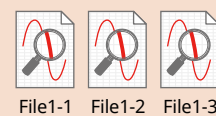

Measurement group 2



Superimposed



Universal Viewer

### Application examples

Acquire temperature and vibration data from power plant turbines

- Monitoring and recording of alarms when abnormal temperature or vibration are detected
- At 5 ms sampling, reliably detect abnormalities
- Dual interval multipoint measurement



Measures LCD projector overheating

- Evaluates the rise in temperature of parts near the projector lamp, and the drop in temperature after powering OFF
- At 10 to 1 ms sampling, record steep temperature changes in detail

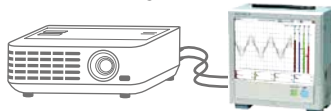

Car battery charge/discharge test

- Measures transient current during charging and discharging
- Sampling requirement: 1 ms

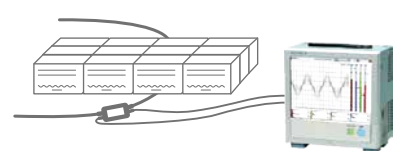

## MATH (including reports), and event actions

### MATH function (/MT option)

Supports various kinds of math computation, including basic math and functions (square root, logarithms, trigonometry). Write formulas using variables for measured or computed data and save or display the results—this saves time and effort on post-processing. Create hourly, daily, monthly, and other reports with the Report function.

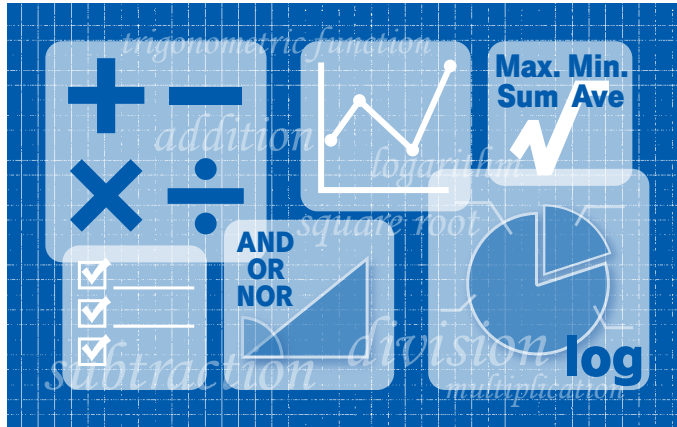

### Event actions

Ability to assign actions tied to specific events during the operation of the data acquisition station.

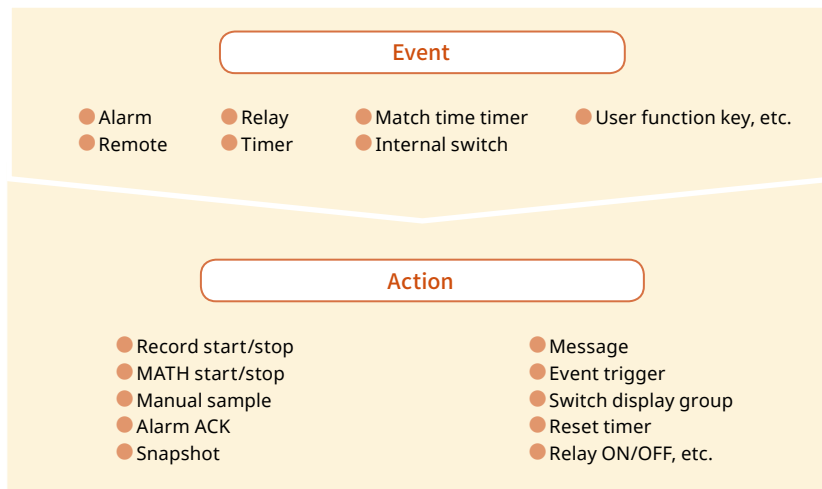

## Report creation and network functions (/MT option)

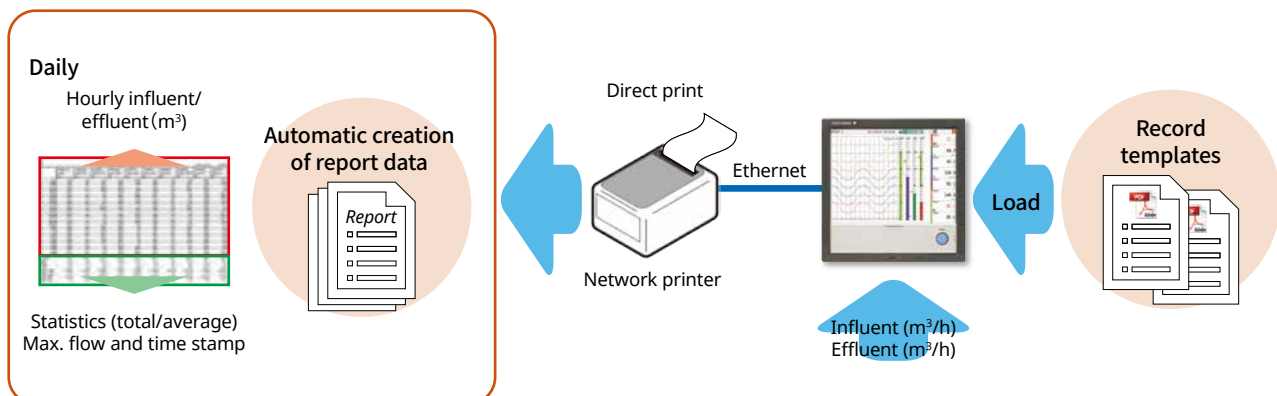





# Provides a variety of convenient networking functions

## Networking

### Modbus/TCP and Modbus/RTU Communications

GX/GP supports Modbus TCP/IP client and server modes for Ethernet communications and Modbus RTU master and slave modes for optional serial communications.

#### Modbus/TCP (Ethernet connection), Modbus/RTU (RS-422/485 connection)

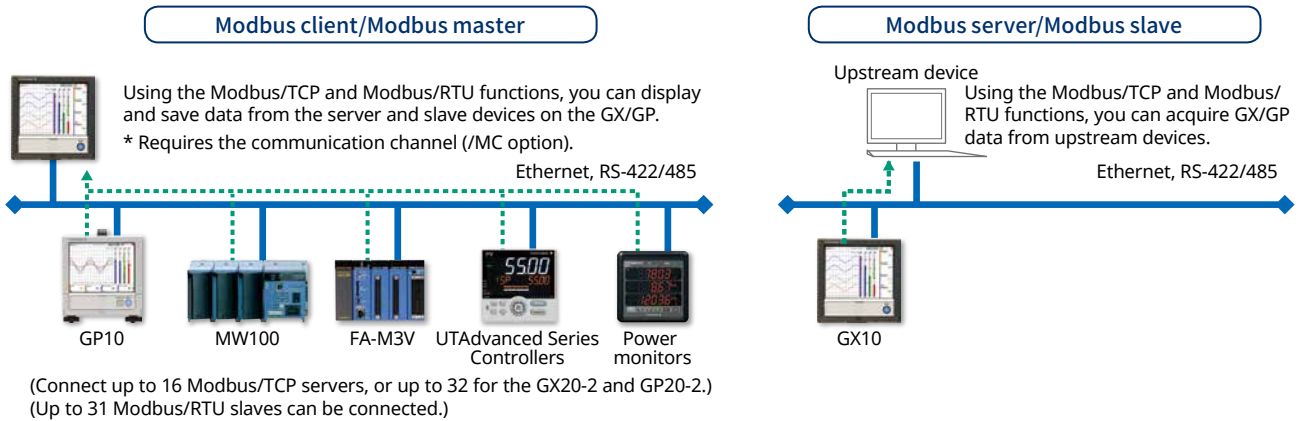

### EtherNet/IP Function (/E1 option)

GX/GP supports EtherNet/IP server functions. You can access GX/GP from PLCs or other devices and load measurement/MATH channels or write\* to communication input channels (GX10/GP10: max. 50 ch, GX20-1/GP20-1: max. 300 ch, GX20-2/GP20-2: max. 500 ch).

\* Communication channel function (/MC option) is required.

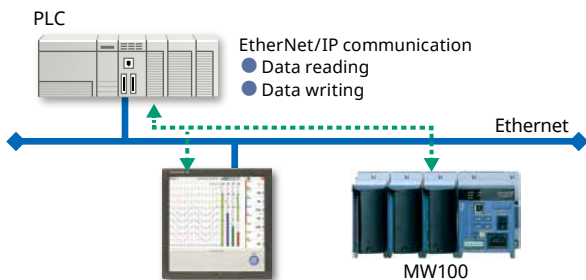

### CC-Link family SLMP communication (/E4 option)

Protocol function that enables connection from a GX/GP to Mitsubishi Electric PLCs without sequencer programs. You can run the GX/GP as an SLMP client, enabling writing of GX/GP measured data to the PLC and writing of PLC data to communication channels.\*

\*Requires the communication channel function (/MC option).

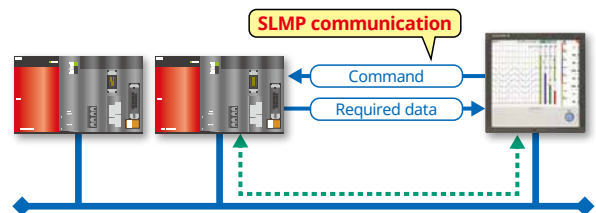

### Powerful tool for instrument performance evaluation testing (/E2 and /MC options)

Highly precise measured data from power measuring instruments (WT series power analyzers) can be acquired without loss of fidelity on the GX/GP, and recorded and displayed alongside the GX/GP's own measured data. This is ideal for performance evaluation testing because you can record instrument power consumption, temperature, and other phenomena simultaneously.

#### Models that can be connected

Yokogawa Meters & Instruments Corp., WT series power analyzers, WT300/WT300E (command mode WT300), WT500, WT1800/WT1800E (command type WT1800)

#### Max. no. of connections

8 (GX10/GP10), 16 (GX20/GP20)

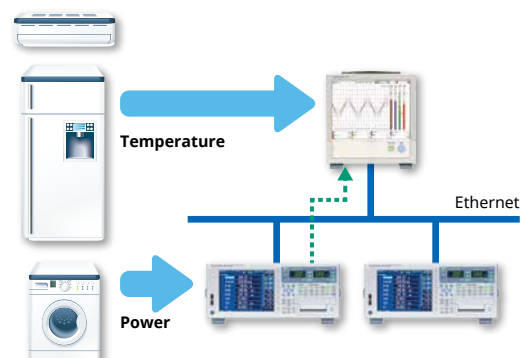

## OPC-UA Server (/E3 option)

Data acquired by the GX/GP can be accessed through Ethernet communication from a host system (OPCUA client). Writing from an upstream system to a GX/GP communication channel requires the communication channel function (/MC option).

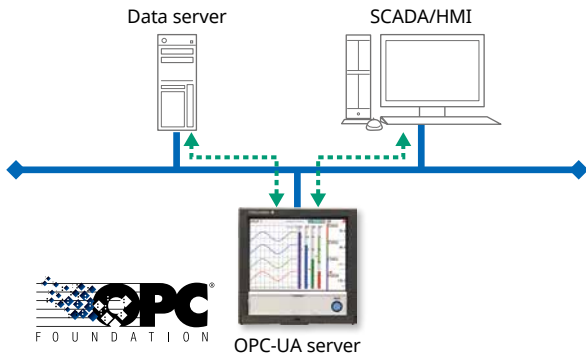

## DARWIN-compatible communication

The GX/GP supports DARWIN communication commands. Use your current DARWIN communication programs as-is on the GX/GP.\*

\* See your dealer or nearest Yokogawa representative for details.

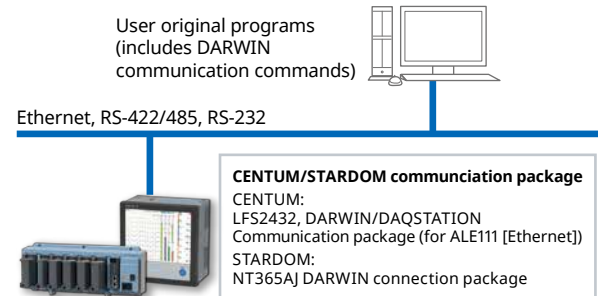

## FTP-based file transfer

The FTP client/server functions allow you to easily share and manage data from a centralized file server.

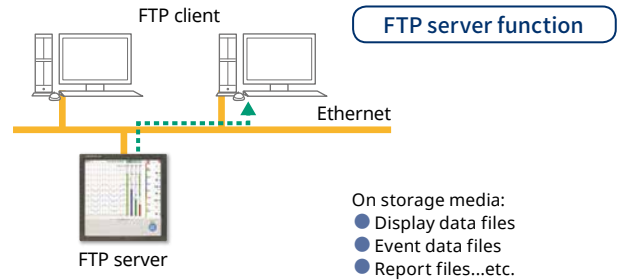
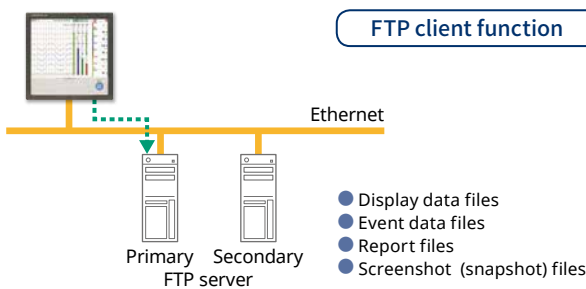

## E-mail messaging function

The GX/GP can send a variety of informative e-mail messages that include alarm notification reports, periodic instantaneous data values, scheduled report data and other information.

### Sending e-mail using an existing mail system

In this type of setup, e-mail messages are sent through an existing mail server (SMTP server).

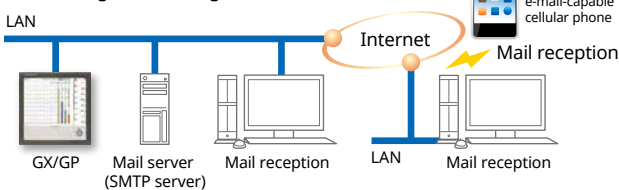

## Time synchronization with network time servers

GX/GP uses SNTP protocol in client mode to acquire time information from a network time-server. This function allows any number of GX/GP units within a facility to have precisely synchronized time; all units will record data with coordinated date and time stamp information. In addition, GX/GP can function as a server, providing time data to other SNTP client units on the network.

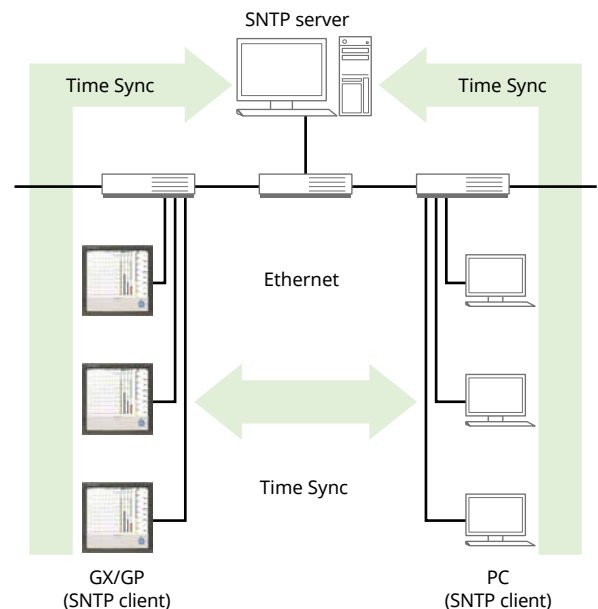

## Automatic network setup (DHCP) function

Using Dynamic Host Configuration Protocol (DHCP), the GX/GP can automatically acquire the settings it needs (IP address) for network communications from a DHCP server. This makes it easier than ever to install the unit on a plant network.

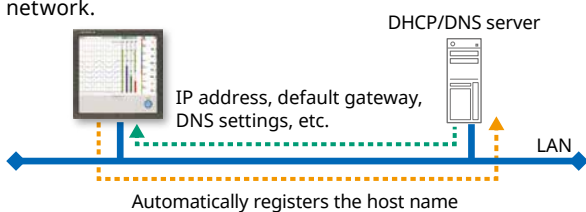



# Rock-solid hardware and highly secure

## Reliability and durability

### Be confident that recorded data is saved

Measured and calculated data is continuously saved to secure, internal non-volatile memory. At manual or scheduled intervals, the files in memory are copied to the removable media. In addition, the files can be copied and archived to an FTP server.

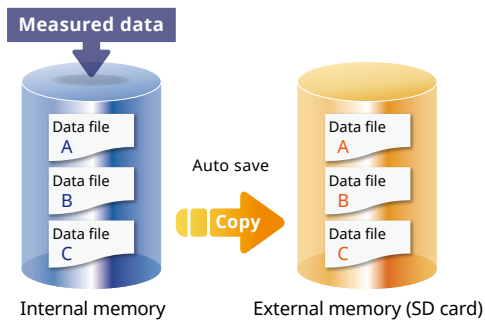

Because of the inherent reliability and security of non-volatile memory, the possibility of losing data under any operating condition or power failure event is extremely small.

### Select file formats according to your application

For increased security, measured data can be saved in binary format. This format is very difficult to decipher or modify in traditional text editors or other programs. To enable easy and direct opening of the data in text editors or spreadsheet programs, choose text format. This allows you to work with your measurement data without dedicated software.

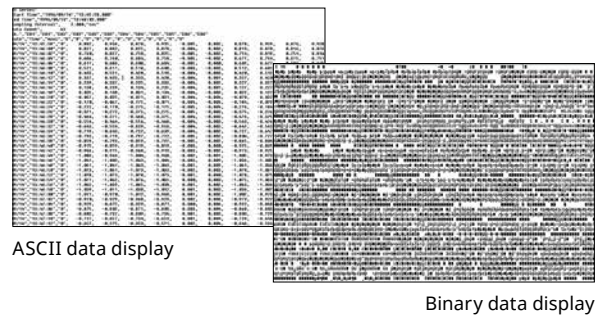

### High Capacity Internal Memory

Even longer recording durations, and multichannel recording.

#### Display data file sample time

Measurement CH = 30 channels. Math CH = 0 channels.

Internal Memory	500 MB
Display update (minute/div)	30 minutes
Sampling period (s)	60 s
Total sample time	Approx. 2.5 years

#### Event data file sample time

Measurement CH = 30 channels. Math CH = 0 channels.

Internal Memory	500 MB
Sampling period (s)	1 s
Total sample time	Approx. 1 months

### 21 CFR Part 11 support (iAS option)

With the expanded security function option, the instruments support the USA FDA's Title 21 CFR Part 11 regulations (for the pharmaceutical manufacturing industry).

It gives you access to a credential-based login function, electronic signatures, audit trails, an anti-tampering function, an Active Directory-based password management function, a sign-in function, and other security features.



FDA 21 CFR PART 11

### Security enhancements

Safely sends and receives customer data.

#### SSL support function

- FTP client
- SMTP client
- FTP server
- HTTP server

#### Digital signatures

- Add electronic signatures to records (PDF)



SSL: An encryption protocol for data sent over TCP/IP networks.

### Front panel door lock

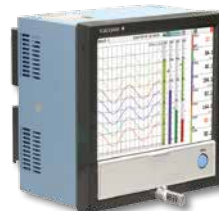

The front panel door can be locked to prevent mishandling of the power switch or external media.

### Analog front end module

A proprietary A/D converter delivers high speed, high precision data acquisition. (High-speed AI, PID Control module)





## Reliable dust- and splash-proof construction

### Dust and splashproof front panel (Complies with IEC529-IP65 and NEMA No. 250 TYPE 4\*)

With its IEC529-IP65 compliant front panel, the GX is ready for use in harsh environments.

\* Except the external icing test



## High environmental worthiness for use in most any setting

The protective sheets on the touch panel display have a special coating on the front and back to prevent damage from scratches, chemicals, and solvents while maintaining a high display clarity and resistance to light interference.

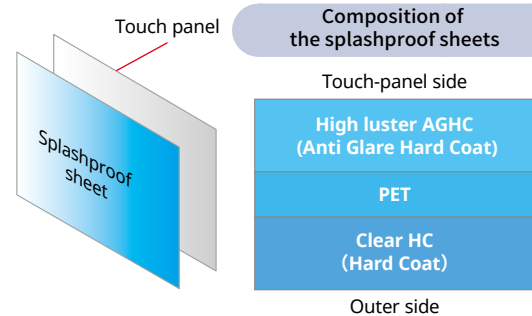

## Multitouch operation even with gloves on

Traditional resistive touch screens can detect only one touch point. The built in controller and algorithm of the GX/GP can detect two touch points, allowing intuitive pan and zoom functions during trend monitoring—a first among paperless recorders.

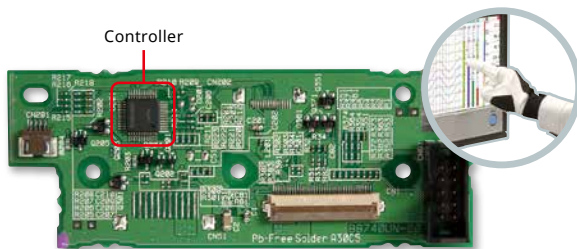

## Heat dissipating construction

The GX/GP was built for heat dissipation to ensure an even temperature distribution between module terminals.

Heat analysis result

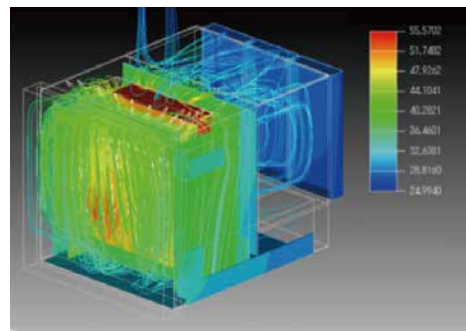

## Actual values support high precision measurement

The measuring accuracies noted in the general specifications have a margin of error that takes into account the product's components and the equipment used for adjustment and testing. However, the actual values calculated from the accuracy testing data upon shipment of the instrument from the factory are as follows.

	Input type	Measuring accuracy* <sup>1</sup> (typical value* <sup>2</sup> )
DCV	20mV	± (0.01% of rdg + 5 μV)
	60mV	± (0.01% of rdg + 5 μV)
	6V (1-5 V)	± (0.01% of rdg + 2 mV)
TC* <sup>3</sup>	R	± 1.1°C
	K	0.0~1370.0°C : ± (0.01% of rdg + 0.2°C)    -200.0~0.0°C : ± (0.15% of rdg + 0.2°C)
	K (-200~500 °C)	0.0~500.0°C : ± 0.2°C    -200.0~0.0°C : ± (0.15% of rdg + 0.2°C)
	J	0.0~1100.0°C : ± 0.2°C    -200.0~0.0°C : ± (0.10% of rdg + 0.2°C)
	T	0.0~400.0°C : ± 0.2°C    -200.0~0.0°C : ± (0.10% of rdg + 0.2°C)
	N	0.0~1300.0°C : ± (0.01% of rdg + 0.2°C)    -200.0~0.0°C : ± (0.22% of rdg + 0.2°C)
RTD	Pt100	± (0.02% of rdg + 0.2°C)
	Pt100 (high resolution)	± (0.02% of rdg + 0.16°C)

\*1 Applies to GX90XA-10-U2, A/D integration time 16.67 ms or more, General operating conditions: 23 ± 2 °C, 55 ± 10% RH, supply voltage 90-132, 180-264 V AC, power frequency within 50/60 Hz ± 1%, warm-up of 30 minutes or more, no vibrations or other hindrances to performance.

\*2 For the measuring accuracy (guaranteed), see the module's general specifications (GS 04L53B01-01EN).

\*3 These values do not include the reference junction compensation accuracy.



Model		GX20	GP20	GX10	GP10
Construction		Vertical panel mount	Portable	Vertical panel mount	Portable
	Panel thickness	2 to 26 mm		2 to 26 mm	
Display		12.1" TFT color LCD (800 × 600 dots)		5.7" TFT color LCD (640 × 480 dots)	
Touch screen		4 wire resistive touch screen, 2-point touch detection			
Max. no. of connectable modules		10 (When mounted on expansion module: 9)		3 (When mounted on expansion module: 2)	
		* The maximum number of connectable modules is limited by the maximum number of I/O channels, and differs depending on the types and combinations of modules.			
Analog input channels		Standard: 100, Large memory: 450 (with expansion unit)		Standard: 30, 100 (with expansion unit)	
No. of mathematical channels		GX20-1, GP20-1: 100, GX20-2, GP20-2: 200		50	
No. of communication channels		Standard: 300, Large memory: 500		50	
Internal memory (flash memory)		Standard: 500 MB, Large memory: 1.2 GB		500 MB	
External storage media		SD memory card (up to 32 GB) (format: FAT32 or FAT16), 1 GB included USB interface (/UH option): USB 2.0 compliant (external storage media: USB flash memory) (Keyboard/mouse: HID Class Ver. 1.1 compliant)			
Communication functions		Ethernet (10BASE-T/100BASE-TX), IEEE802.3 compliant (Ethernet frame type: DIX) Connecting configuration: Cascade max. 4 level (10BASE-T), max. 2 level (100BASE-TX), segment length: Max. 100 m E-mail inform function (E-mail client), FTP client function, FTP server function, Web server function, SNTP client function, SNTP server function, DHCP client function Modbus/TCP (client/server functions) * /MC option is required.			
Options		Serial communications (/C2: RS-232, /C3: RS-422 or RS-485), Modbus/RTU (master/slave functions) EtherNet/IP communication (PLC communication protocol) (/E1), WT communication (/E2), OPC-UA server (/E3), SLMP communication (Mitsubishi PLC) (/E4)			
Other functions		Security functions: Key lock function, login function, Clock functions: With calendar function, accuracy: ± 5 ppm (0 to 50°C), LCD saver function			
Rated supply voltage		100 to 240 VAC (allowable power supply voltage range: 90 to 132 VAC, 180 to 264 VAC) 12 VDC (allowable power supply voltage range: 10 to 20 VDC, only for a GP10 of power supply voltage code "2")			
Rated supply frequency		50/60 Hz			
Power consumption		Max. 90 VA (100 VAC), max. 110 VA (240 VAC)		Max. 45 VA (100 VAC), max. 60 VA (240 VAC)	
Insulation resistance		Between the Ethernet, RS-422/485, and each insulation terminal and earth: 20 MΩ or greater (at 500 VDC)			
Withstand voltage		Between the power terminal and earth: 3000 V AC (50/60 Hz) for one minute			
External dimensions (W × H × D)	Main Unit	288 × 288 × 169 (mm)	288 × 318 × 197 (mm)	144 × 144 × 174 (mm)	144 × 168 × 197 (mm)
	Including modules	288 × 288 × 220 (mm)	288 × 318 × 248 (mm)	144 × 144 × 225 (mm)	144 × 168 × 248 (mm)
Weight (main unit only)		Approx. 6.0 kg	Approx. 5.4 kg	Approx. 2.1 kg	Approx. 1.9 kg

### Analog input module (Universal input module)

Model	GX90XA												
Input type (Inputs: 4/6/10)	DC voltage <sup>*1</sup> , standardized signal <sup>*1</sup> , thermocouple <sup>*1</sup> , RTD <sup>*2</sup> , DI <sup>*1</sup> , DC current (with external shunt resistor) <sup>*1</sup> , DC current <sup>*3</sup> , resistance <sup>*4</sup>												
	DC voltage	20 mV, 60 mV, 200 mV, 1 V, 2 V, 6 V, 20 V, 50 V, 100 V <sup>*5</sup>					RTD	Pt100, JPt100, Cu10 GE, Cu10 L&N, Cu10 WEED, Cu10 BAILEY, Cu10 (20°C) α=0.00392, Cu10 (20°C) α=0.00393, Cu25 (0°C) α=0.00425, Cu53 (0°C) α=0.00426035, Cu100 (0°C) α=0.00425, J263B, Ni100 (SAMA), Ni100 (DIN), Ni120, Pt25, Pt50, Pt200 WEED, Cu10 GOST, Cu50 GOST, Cu100 GOST, Pt46 GOST, Pt100 GOST, PT500 <sup>*4</sup> , PT1000 <sup>*4</sup>					
	Standard signal	0.4-2 V, 1-5 V						DI	Level, Contact				
	Resistance	20, 200, 2000 Ω					DC current	0-20 mA, 4-20 mA					
Scan intervals	1/2/5/10/20/50/100/200/500ms, 1/2/5s												
	Scan interval by type												
	Suffix code	Scan interval											
		1ms	2ms	5ms	10ms	20ms	50ms	100ms	200ms	500ms	1s	2s	5s
	-U2	—	—	—	—	—	—	○	○	○	○	○	○
	-C1	—	—	—	—	—	—	○	○	○	○	○	○
	-L1	—	—	—	—	—	—	—	—	○	○	○	○
-T1	—	—	—	—	—	—	—	—	—	○	○	○	
-H0	○	○	○	○	○	○	○	○	○	○	○	○	
-R1	—	—	—	—	—	—	○	○	○	○	○	○	
Power supply and consumption	Supplied from main unit, power consumption: 2 W or less												
Insulation resistance	Between input circuits and internal circuitry: 20 MΩ or greater (at 500 V DC)												
Withstand voltage	Between the input circuits and the internal circuitry: 3000 VAC for one minute (current input type and low withstand voltage type: 1500 VAC for one minute) Between analog input channels: 1000 V AC for one minute (excluding b terminals for universal input type) (low withstand voltage type: 400 VAC for one minute, high speed universal type: 3000 V AC for one minute)												
Terminal types	M3 screw terminals or clamp terminals												
Weight	Approx. 0.3 kg												

\*1 Cannot be set for the current input type (type suffix code: -C1) or 4-wire RTD/resistance type (type suffix code: -R1).

\*2 Cannot be set for the current input type (type suffix code: -C1), electromagnetic relay type (type suffix code: -T1), or low withstand voltage type (type suffix code: -L1).

\*3 Can only be set with current input type (type suffix code: -C1).

\*4 Can only be set with 4-wire RTD/resistance type (type suffix code: -R1).

\*5 Can only be set with high speed universal type (type suffix code: -H0).

## Analog output module

Model	GX90YA
Output type (outputs: 4)	Transmission output, manual output
Range	4–20 mA or 0–20 mA
Output update interval	100 msec (shortest)
Load resistance	600 Ω or less
Resolution	0.002%
Power supply and consumption	Supplied from main unit, power consumption: 3W or less
Insulation resistance	Between output circuits and internal circuitry: 20 MΩ (at 500 VDC)
	Between output channel terminals: 500 VDC, 20 MΩ or greater
Withstand voltage	Between output circuits and internal circuitry: 1500 AC for one minute
	Between output circuits: 500 VAC for one minute
Terminal type	M3 screw terminals or clamp terminals
Weight	Approximately 0.2 kg

## Digital input module

Model	GX90XD
Input types (inputs: 16)	DI or pulse input <sup>*1</sup> (Open collector or non-voltage contact)
	ON/OFF detection Open collector : Voltage of 0.5 V DC or less when ON, leakage current of 0.5 mA or less when OFF Non-voltage contact : Resistance of 200 Ω or less when ON, 50 kΩ when OFF
Contact rating	12 V DC, 20 mA or more
Power supply and consumption	Supplied from main unit, power consumption : 0.7 W or less
Insulation resistance	Between input terminals and internal circuitry : 20 MΩ or greater (at 500 V DC)
Withstand voltage	Between input terminals and internal circuitry : 1500 V AC for one minute
Terminal types	M3 screw terminals or clamp terminals
Weight	Approx. 0.3 kg

## Pulse input specifications<sup>\*1</sup>

Counting system	The rising edge of the pulse is counted.
Max. pulse period	250Hz (The chattering filter : OFF) 125Hz (The chattering filter : ON)
Minimum detection pulse width	Low (close), High (open), both is 2 ms or more
Pulse detection period	1ms
Pulse measurement accuracy	± 1 pulse
Pulse count interval	Measurement interval
Filter	The chattering filter can be switched On/Off. (When the chattering filter is off, connect GX/GP so that it is not affected by the noise.)

\*1 Integration requires the math function (/MT option).

## Digital output module

Model	GX90YD
Output types (outputs: 6)	Relay contact (c contact)
Rated load voltage	100 to 240 V AC or 5 to 24 V DC
Max. load voltage/current	264 VAC or 26.4 VDC, 3A/point (resistance load)
Power supply and consumption	Supplied from main unit, power consumption: 1.4 W or less
Insulation resistance	Between output terminals and internal circuitry: 20 MΩ (at 500 VDC)
Withstand voltage	Between output terminals and internal circuitry: 3000 V AC for one minute
Terminal types	M3 screw terminals
Weight	Approx. 0.3 kg

## Expandable I/O

Model	GX60
Rated supply voltage	100 to 240 VAC (allowable power supply voltage: 90 to 132 VAC, 180 to 264 VAC)
Rated supply frequency	50 to 60 Hz
Power consumption	Max. 40 VA (100 VAC), max. 55 VA (240 VAC)
Insulation resistance	Between Ethernet terminal, isolated terminals, and ground 20 MΩ or more (at 500 VDC)
Withstand voltage	Between power terminal and ground: 3000 VAC (500/60 Hz)/1 min. Between I/O modules and ground: between each module's internal circuitry and depends on the specification of I/O module.
Weight	Approx. 3.2 kg (installing 6 modules)

## Digital input/output module

Model	GX90WD
Input type (inputs: 8)	DI or pulse input <sup>*2</sup> (Open collector or non-voltage contact)
	ON/OFF detection Open collector : Voltage of 0.5 V DC or less when ON, leakage current of 0.5 mA or less when OFF Non-voltage contact : Resistance of 200 Ω or less when ON, 50 kΩ when OFF
Output type (outputs: 6)	Contact input rating 12 VDC, 20 mA or more
	Rated load voltage Relay contact (C contact) When connected to the main circuit (first-order power supply), 150 VAC or less When connected to a circuit derived from the main circuit (second-order power supply), 250 VAC or less (the main circuit is 300 VAC or less and uses an isolated transformer) or 30 VDC or less
Power consumption	2 A (DC)/2 A (AC), resistive load
Insulation resistance	1.9 W or less
Withstand voltage	Between input terminals and internal circuitry: 20 MΩ or greater (at 500 VDC)
	Between output terminals and internal circuitry: 20 MΩ or greater (at 500 VDC)
Terminal types	Between input terminals and internal circuitry: 1500 VAC for one minute Between output terminals and internal circuitry: 3000 VAC for one minute
Weight	M3 screw terminals
	Approx. 0.3 kg

Each unit (GX/GP main unit and expandable I/O), can use 1 module only.

## Pulse input specifications

Please see the pulse input specifications of Digital Input Module.

\*2 Integration requires the math function (/MT option).

## Pulse Input Module

Model	GX90XP
Number of inputs	10
Measurement interval	100 ms (shortest)
Input type	Contact (open collector, voltage-free contact), level (5 V logic)
Input range	Up to 20 kHz * 30 Hz when the chattering filter is in use (On)
Minimum detection pulse width	25 μs <sup>*</sup> * 15 ms when the chattering filter is in use (On)
Measurement accuracy	Count ± 1 pulse During integration, the following accuracies are added. Upon MATH start: +1 measuring period Upon MATH stop: -1 measuring period * Integration requires the math function (optional code /MT).
Chattering filter	Removes chattering up to 5 ms (can be turned on/off on each channel)
Hysteresis width	Approx. 0.2 V
Contact, transistor rating	Contact: 15 V DC or higher and 30 mA or higher rating. Minimum applicable load current 1 mA or less. Transistor: With the following ratings: Vce>15 VDC, Ic>30 mA
Maximum input voltage	± 10 V DC
Insulation resistance	Between input terminals and internal circuitry: 20 MΩ or greater at 500 V DC
Withstand voltage	Between input terminals and internal circuitry: 1500 V AC for 1 minute

## PID control module

Model	GX90UT	
Number of control loops	Number of loops	2
	Measured points	2
Analog input (measured input)	Measurement type	DC voltage (DCV)/standardized signal, TC/RTD, DI (LEVEL and non-voltage contact)/DC current (with external shunt resistance)
	Scan (control) interval	100 ms or 200 ms (system global setting)
Analog output (control output/transmission output/sensor power supply)	Outputs	2
	Output type	Power supply for current, voltage pulse, or sensors. Current output: 4–20 mA or 0–20 mA Voltage pulse output: ON voltage = 12 VDC or more (load resistance 600 Ω or more), OFF voltage = 0.1 VDC or less Can be used as a sensor power supply (13.0–18.3 VDC)
Digital input (switching the SP, operation mode, etc.)	Inputs	8
	Input format	Non-voltage contact and open collector Contact rating: 12 VDC or more, 20 mA or more
Digital output (of alarms, events, etc.)	Outputs	8
	Output format	Open collector (sink type)
Withstand voltage/insulation resistance	Output contact capacity	Max 24 VDC, 50 mA
		See PID control module general specifications (GS 04L51B01-31EN)
Terminal type		M3 screw terminals
Weight		Approximately 0.3kg



## GX10/GX20 MODEL AND SUFFIX CODES

Model	Suffix Code	Optional code	Description
GX10			Paperless recorder (Panel mount type, Small display) <sup>*14</sup>
GX20			Paperless recorder (Panel mount type, Large display) <sup>*14</sup>
Type	-1		Standard (Max. measurement channels: 100 ch)
	-2		Large memory (Max. measurement channels: 500 ch) <sup>*12</sup>
Display language	E		English, degF, DST (summer/winter time) <sup>*10</sup>
Optional features	/AH		Aerospace heat treatment
	/AS		Advanced security function (Part 11) <sup>*20</sup>
	/BC		Black cover
	/BT		Multi-batch function <sup>*21</sup>
	/C2		RS-232 <sup>*1</sup>
	/C3		RS-422/485 <sup>*1</sup>
	/CG		Custom display <sup>*15</sup>
	/D5		VGA output <sup>*2</sup>
	/E1		EtherNet/IP communication (PLC communication protocol)
	/E2		WT communication <sup>*13</sup>
	/E3		OPC-UA sever
	/E4		SLMP communication (Mitsubishi PLC)
	/FL		Fail output, 1 point
	/LG		Log scale
	/MT		Mathematical function (with report function)
/MC		Communication channel function	
/P1		24 V DC/AC power supply	
/PG		Program control function <sup>*22</sup>	
/UH		USB interface (Host 2 ports)	

## GP10/GP20 MODEL AND SUFFIX CODES

Model	Suffix Code	Optional code	Description
GP10			Paperless recorder (Portable type, Small display) <sup>*14</sup>
GP20			Paperless recorder (Portable type, Large display) <sup>*14</sup>
Type	-1		Standard (Max. measurement channels: 100 ch)
	-2		Large memory (Max. measurement channels: 500 ch) <sup>*12</sup>
Display language	E		English, degF, DST (summer/winter time) <sup>*10</sup>
Power supply		1	100V AC, 240V AC <sup>*16</sup>
		2	12 VDC <sup>*17</sup>
Power cord		D	Power cord UL/CSA standard
		F	Power cord VDE standard
		R	Power cord AS standard
		Q	Power cord BS standard
		H	Power cord GB standard <sup>*</sup>
		N	Power cord NBR standard
Optional features		W	Screw terminal, power cord not included
	/AH		Aerospace heat treatment
	/AS		Advanced security function (Part 11) <sup>*20</sup>
	/BT		Multi-batch function <sup>*21</sup>
	/C2		RS-232 <sup>*1</sup>
	/C3		RS-422/485 <sup>*1</sup>
	/CG		Custom display
	/D5		VGA output <sup>*2</sup>
	/E1		EtherNet/IP communication
	/E2		WT communication <sup>*13</sup>
	/E3		OPC-UA sever
	/E4		SLMP communication (Mitsubishi PLC)
	/FL		Fail output, 1 point
	/LG		Log scale
	/MT		Mathematical function (with report function)
/MC		Communication channel function	
/PG		Program control function <sup>*22</sup>	
/UH		USB interface (Host 2 ports)	

## Analog input module, Digital I/O module:When the built-in module

Please add the following suffix codes to the main unit model and specification codes.

Option	Optional code	Description	Models and numbers of units of modules included in the main unit
Optional features (Analog input) <sup>*3,*11</sup>	/UC10	With analog input module, 10 ch (Clamp terminal)	GX90XA-10-U2N-CN x 1
	/UC20	With analog input module, 20 ch (Clamp terminal) <sup>*7</sup>	GX90XA-10-U2N-CN x 2
	/UC30	With analog input module, 30 ch (Clamp terminal) <sup>*8</sup>	GX90XA-10-U2N-CN x 3
	/UC40	With analog input module, 40 ch (Clamp terminal) <sup>*5</sup>	GX90XA-10-U2N-CN x 4
	/UC50	With analog input module, 50 ch (Clamp terminal) <sup>*5</sup>	GX90XA-10-U2N-CN x 5
	/US10	With analog input module, 10 ch (M3 screw terminal)	GX90XA-10-U2N-3N x 1
	/US20	With analog input module, 20 ch (M3 screw terminal) <sup>*7</sup>	GX90XA-10-U2N-3N x 2
	/US30	With analog input module, 30 ch (M3 screw terminal) <sup>*8</sup>	GX90XA-10-U2N-3N x 3
	/US40	With analog input module, 40 ch (M3 screw terminal) <sup>*5</sup>	GX90XA-10-U2N-3N x 4
	/US50	With analog input module, 50 ch (M3 screw terminal) <sup>*5</sup>	GX90XA-10-U2N-3N x 5
Optional features (Digital I/O) <sup>*4</sup>	/CR01	With digital I/O module, (Output:0, Input:16) <sup>*8,*9</sup>	GX90XD-16-11N-3N x 1
	/CR10	With digital I/O module, (Output:6, Input:0) <sup>*8,*9</sup>	GX90YD-06-11N-3N x 1
	/CR11	With digital I/O module, (Output:6, Input:16) <sup>*7,*8,*9</sup>	GX90XD-16-11N-3N x 1, GX90YD-06-11N-3N x 1
	/CR20	With digital I/O module, (Output:12, Input:0) <sup>*6,*9</sup>	GX90YD-06-11N-3N x 2
	/CR21	With digital I/O module, (Output:12, Input:16) <sup>*6,*9</sup>	GX90XD-16-11N-3N x 1, GX90YD-06-11N-3N x 2
	/CR40	With digital I/O module, (Output:24, Input:0) <sup>*6,*9</sup>	GX90YD-06-11N-3N x 4
	/CR41	With digital I/O module, (Output:24, Input:16) <sup>*6,*9</sup>	GX90XD-16-11N-3N x 1, GX90YD-06-11N-3N x 4

\*1 /C2 and /C3 cannot be selected together.

\*2 /D5 can be specified only for the GX20 or GP20.

\*3 Only one option can be specified.

\*4 Only one option can be specified.

\*5 /UC40, /UC50, /US40 and /US50 cannot be specified for the GX10 or GP10.

\*6 /CR20, /CR21, /CR40 and /CR41 cannot be specified for the GX10 or GP10.

\*7 If /UC20 or /US20 is specified, /CR11 cannot be specified for the GX10 or GP10.

\*8 If /UC30 or /US30 is specified, /CR01, /CR10 and /CR11 cannot be specified for the GX10 or GP10.

\*9 A digital input module has M3 screw terminals.

\*10 The Display language is selectable from English, German, French, Russian, Korean, Chinese, Japanese. To confirm the current available languages, please visit the following website.

URL: <http://www.yokogawa.com/ns/language/>

\*11 Solid state relay scanner type (type suffix code: -U2).

If you need the electromagnetic relay scanner type, purchase it separately.

\*12 Large memory type can be specified only for the GX20/GP20.

\*13 /MC option must be separately specified when the WT communication is selected.

\*14 To connect an expandable I/O, you will need one expansion module for the GX/GP.

\*15 Creating custom displays requires DXA170 DAQStudio (sold separately). (GX/GP does not have a creation function.)

\*16 Power code can be specified the suffix code D, F, R, Q, H, or N.

\*17 12 VDC power supply can be specified only for the GP10 without power code (suffix code: W).

\*18 Optional code /MT (MATH) required if using the GX90XD's or GX90WD's pulse input.

\*19 The /MT option (MATH) is required to perform pulse integration on GX90XP pulse input modules.

\*20 When the Advanced Security function is ON the scan interval is 100 ms or more, and the Dual Interval function and PID modules are unavailable.

\*21 When the Multibatch function is ON the scan interval is 500 ms or more, and the Dual Interval function is unavailable.

\*22 Using the Program Control function requires the PID control module.

\* When ordering units with built-in modules, the total number of channels allowed is 100 (10 modules) including any modules ordered individually.

**Analog input module, Digital I/O module:When the individual modules  
MODEL and SUFFIX Code (GX90XA)**

Model	Suffix Code	Description
GX90XA		Analog Input Module
Number of channels	-4	4 channels (-H0 type only)
	-6	6 channels (-R1 type only)
	-10	10 channels
Type	-C1	Current, scanner type (isolated between channels)
	-L1	Low withstand voltage DCV/TC/DI, scanner type (isolated between channels)
	-U2	Universal, Solid state relay scanner type (3-wire RTD b-terminal common)
	-T1	DCV/TC/DI, Electromagnetic relay scanner type (Isolated between channels)
	-H0	High speed universal, individual A/D type (isolated between channels)
	-R1	4-wire RTD/resistance, scanner type (isolated between channels)
—	N	Always N
Terminal form	-3	Screw terminal (M3)
	-C	Clamp terminal*
Area	N	General

**MODEL and SUFFIX Code (GX90WD)**

Model	Suffix code	Description
GX90WD		Digital Input/Output Module
Number of channels	-0806	8 channel DIs, 6 channel DOs
Type	-01	Input: Open collector/non-voltage contact (shared common), rated 5 VDC Output: Relay, SPDT (NO-C-NC)
	N	Always N
Terminal form	-3	Screw terminal (M3)
Area	N	General

**MODEL and SUFFIX Code (GX90YD)**

Model	Suffix code	Description
GX90YD		Digital Output Module
Number of channels	-06	6 channels
Type	-11	Relay, SPDT(NO-C-NC)
—	N	Always N
Terminal form	-3	Screw terminal (M3)
Area	N	General

**MODEL and SUFFIX Code (GX60 Expandable I/O)**

Model	Suffix code	Description
GX60		I/O Base Unit
Type	-EX	I/O expansion
Area	N	General
Power supply	1	100V AC, 240V AC
Power cord	D	Power cord UL/CSA standard
	F	Power cord VDE standard
	R	Power cord AS standard
	Q	Power cord BS standard
	H	Power cord GB standard
	N	Power cord NBR standard
	W	Screw terminal (power cord not included)

\* With GX90EX (I/O expansion module).

\* The dummy cover is not attached to the GX60 when shipped from the factory. If you need the dummy cover, please purchase it separately.

**MODEL and SUFFIX Code (GX90XP)**

Model	Suffix code	Description
GX90XP		Pulse Input Module
Number of channels	-10	10 channels
Type	-11	DC voltage/open collector/non-voltage contact (shared common), rated 5 VDC
—	N	Always N
Terminal form	-3	Screw terminal (M3)
	-C	Clamp terminal
Area	N	General

**MODEL and SUFFIX Code (GX90EX Expansion Module)**

Model	Suffix code	Description
GX90EX		I/O Expansion Module
Port	-02	2 ports
Type	-TP1	Twisted pair cable
—	N	Always N
Area	-N	General

**MODEL and SUFFIX Code (GX90XD)**

Model	Suffix Code	Description
GX90XD		Digital Input Module
Number of channels	-16	16 channels
Type	-11	Open collector/Non-voltage, contact (shared common), Rated 5 VDC
—	N	Always N
Terminal form	-3	Screw terminal (M3)
	-C	Clamp terminal
Area	N	General

**MODEL and SUFFIX Code (GX90YA)**

Model	Suffix Code	Description
GX90YA		Analog output module
Number of channels	-04	4 channels
Type	-C1	Current output (isolated between channels)
—	N	Always N
Terminal form	-3	Screw terminals (M3)
	-C	Clamped terminals
Area	N	General

**MODEL and SUFFIX Code (GX90UT)**

Model	Suffix Code	Description
GX90UT		PID control module
Number of loops	-02	2 loops
Type	-11	8 DIs, 8 DOs
—	N	Always N
Terminal form	-3	Screw terminals (M3)
Area	N	General

**Standard Accessories**

Product	Qty
Mounting bracket (GX10 or GX20)	2
SD memory card (1GB)	1
Stylus	1
Tag sheet	1
Sheet (paper)	1
Power cord (for GP10 or GP20 of AC power supply only)	1

**Optional Accessories (Sold Separately)**

Product	Part Number/Model
SD memory card (1GB)	773001
Mounting bracket (for GX10 or GX20)	B8740DY
Stylus pen (touch pen)	B8740BZ
Shunt resistor for screw terminal (M3) (10 Ω ± 0.1%)	415942
Shunt resistor for screw terminal (M3) (100 Ω ± 0.1%)	415941
Shunt resistor for screw terminal (M3) (250 Ω ± 0.1%)	415940
Shunt resistor for clamp terminal (10 Ω ± 0.1%)	438922
Shunt resistor for clamp terminal (100 Ω ± 0.1%)	438921
Shunt resistor for clamp terminal (250 Ω ± 0.1%)	438920
Dummy cover	B8740CZ
Validation Documents (For /AS option)	773230

**Application Software (sold separately)**

Model	Description	OS
DXA170	DAQStudio	Windows 7/8.1/10
GA10	Data Logging Software	Windows 7/8.1/10 Windows Server 2008/2012/2016

● **Calibration certificate (sold separately)**

When ordering the GX10/GX20/GP10/GP20 with options (analog input), the calibration certificate for the modules is included in and shipped with the calibration certificate of the main unit. When ordering an analog input module separately, each module gets its own calibration certificate (one certificate per module).

● **Test certificate (QIC, sold separately)**

When ordering the GX10/GX20/GP10/GP20 with options (analog/digital I/O), the QIC for each module is included in and shipped with the QIC of the main unit. When ordering analog input modules and digital I/O modules separately, each module gets its own QIC (one QIC per module).

● **User's Manual**

Product user's manuals can be downloaded or viewed at the following URL.  
URL: [www.smartdacplus.com/manual/en/](http://www.smartdacplus.com/manual/en/)

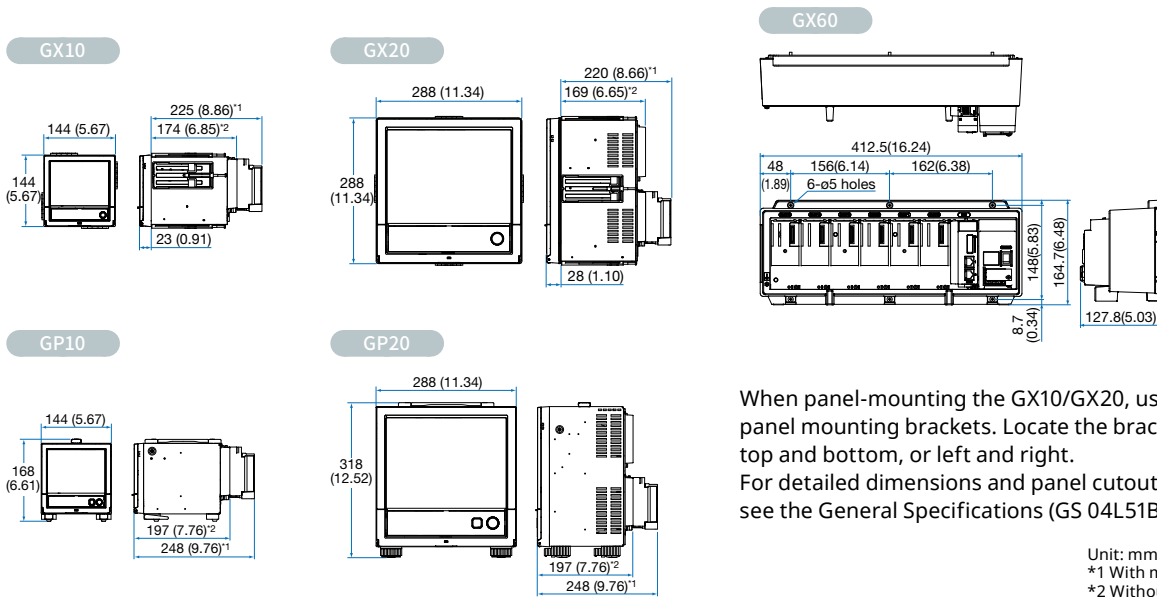

## GM Data Acquisition System

### Data logger that's flexible in form and function

This is a flexible data logger that combines the safety and ease of use that is made possible through our years of experience in measurement technology. Modules and functions are interchangeable with the GX/GP.

#### Flexibly scales to expand the number of channels

- Measure up to 420 ch
- Slide lock for easy attachment and removal

#### Easy access from a web browser

- Hardware settings
- Real time monitoring

#### Supports mobile connection

- Bluetooth communication
- Monitor and configure from a tablet

#### Open network

- Supports Modbus, Ethernet/IP, SLMP, OPC-UA server

#### Designed for high performance, high reliability

- High measurement accuracy
- Redundancy through internal and external memory, plus media

#### Environmental and noise resistance

- Wide operating temperature range: -20 to 60 DEG C



## Configuration example

(When ordering individual instruments)  
 (with supply voltage of 100 to 240 VAC, universal input, and screw terminal)

### 30 ch (analog input)

GX20-1E ×1  
 GX90XA-10-U2N-3N ×3

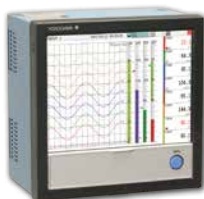

### 120 ch (analog input)

GX20-2E × 1  
 GX90EX-02-TP1N-N (for main unit) × 1  
 GX60-EXN1W  
 (including GX60 Expandable I/O) × 1  
 GX90XA-10-U2N-3N × 12



### 450 ch (analog input)

GX20-2E × 1  
 GX90EX-02-TP1N-N(for main unit) × 1  
 GX60-EXN1W  
 (including GX60 Expandable I/O) × 6  
 GX90XA-10-U2N-3N × 45



#### Analog input module scan interval and measurement type

Type	Channels	Scan interval (shortest)	Scanner	TC	RTD	DCV	DI	mA	Resistance	Feature
Universal (-U2)	10	100ms	SSR	○	○	○	○			Universal
Low withstand voltage relay (-L1)	10	500ms	SSR	○		○	○			Mid-price
Electromagnetic relay (-T1)	10	1s	Relay	○		○	○			Noise-resistance
DC current input (-C1)	10	100ms	SSR					○		mA only
High speed universal (-H0)	4	1ms	—	○	○	○	○			High speed measurement
4-wire RTD/resistance (-R1)	6	100ms	SSR		○				○	4-wireRTD

## Data Logging Software GA10 (sold separately)

### Centrally acquire data from multiple devices on a PC

GA10 is a PC based software package that acquires real time data from SMARTDAC+ data acquisition systems and other devices connected to a network. Connected PCs can monitor real time and historical data, which can be stored on a PC harddrive or centrally on a network drive.

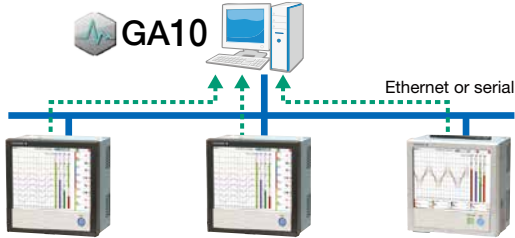

Max. connectable units: **100**  
 Max. recording tags (channels): **2,000**  
 Scan interval: **100 ms** (channels)

Compatible with other models in addition to the GX/GP!



DX series



μR series



MV series

Supports many other models. For details, see the GA10 catalog.

### Aggregate data for monitoring!



Easy to read screen layouts provide operator friendly real time monitoring.

- Group channels any way you like
- Play back data up to recording start, even during measurement
- Instantly recognize alarms (in red)

### Save the data all together!

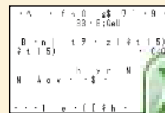

Binary



Excel

Data is stored in a binary tamper proof format preventing unauthorized access. Data can also be exported to excel format for data manipulation and analysis.

## Application example

### Data monitoring in manufacturing sites

Monitor factory data from the office.  
 You can also add clients and share data across multiple PCs.

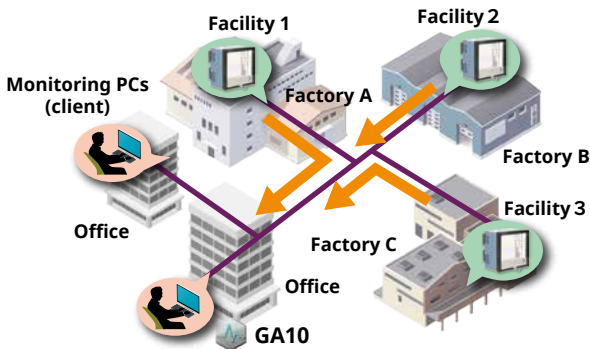

**Effect: No more moving around large factories to do work!**

### Recording data from multiple equipments

Saves testing/manufacturing equipment data on a PC. In addition to simultaneous acquisition, you can acquire data from different equipment at different timing (multilogging).

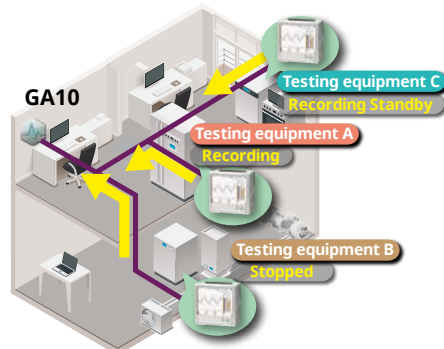

**Effect: Manage all data on the PC, one set of equipment at a time!**

SMARTDAC+ and SMARTDACPLUS are registered trademarks of Yokogawa Electric Corporation.  
 Microsoft and Windows are registered trademarks or trademarks of Microsoft Corporation in the United States and other countries.  
 Other company names and product names appearing in this document are registered trademarks or trademarks of their respective holders.

#### NOTICE



Before operating the product, read the instruction manual thoroughly for proper and safe operation.

#### YOKOGAWA ELECTRIC CORPORATION

Control Instruments Sales Division  
 E-mail: ns@cs.jp.yokogawa.com

<http://www.yokogawa.com/>

#### YOKOGAWA CORPORATION OF AMERICA

YOKOGAWA EUROPE B.V.

<http://www.yokogawa.com/us/>

#### YOKOGAWA ENGINEERING ASIA PTE. LTD.

<http://www.yokogawa.com/eu/>

<http://www.yokogawa.com/sg/>

Sign up for our free e-mail newsletter  
[www.yokogawa.com/ns/](http://www.yokogawa.com/ns/)

Subject to change without notice  
 All Rights Reserved. Copyright © 2012, Yokogawa Electric Corporation

AZ-S-2E  
 Printed in Japan, 705(AZ) [Ed:07/d]